

# 8851

Pneu  
matic

LEGO

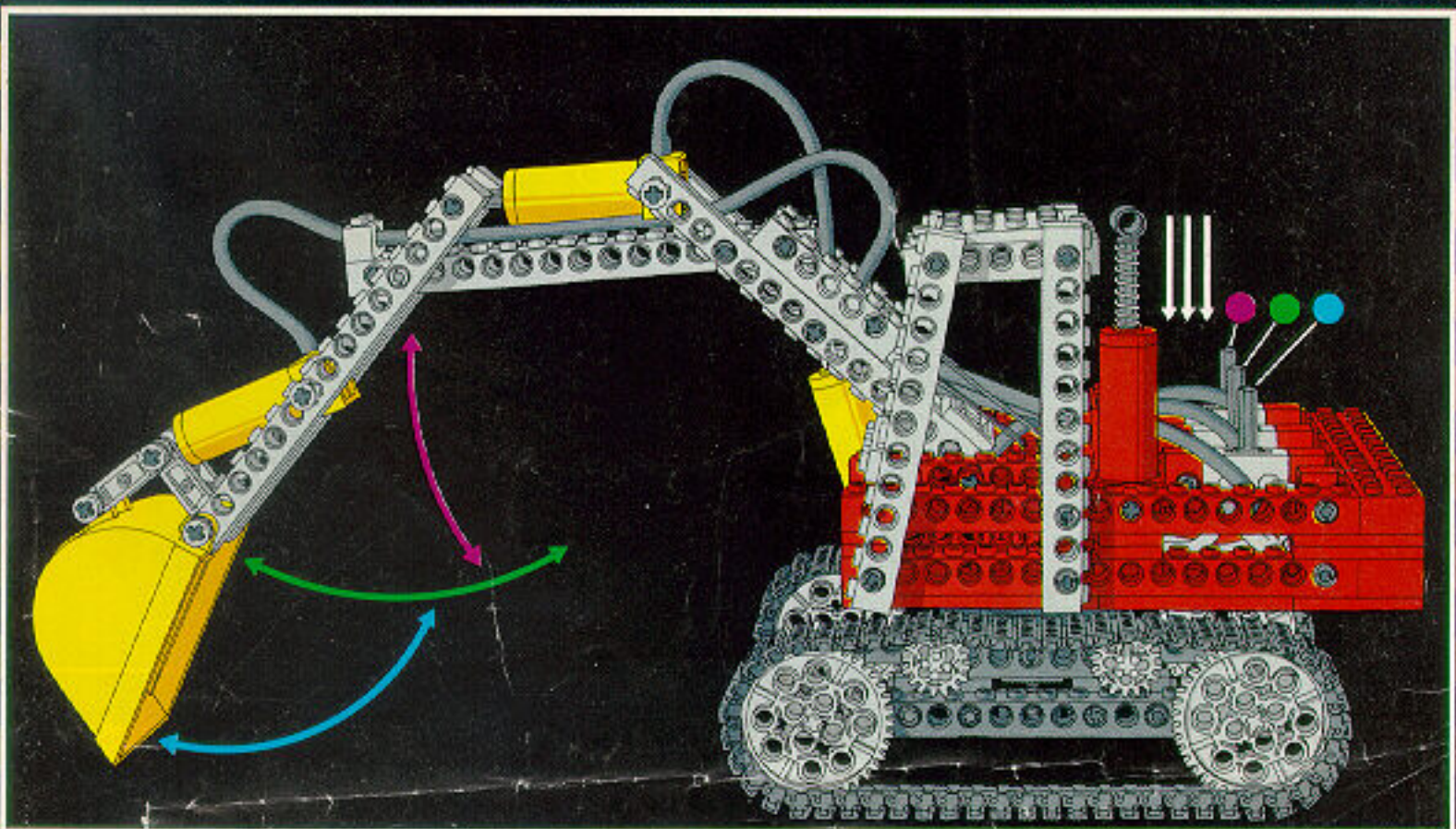

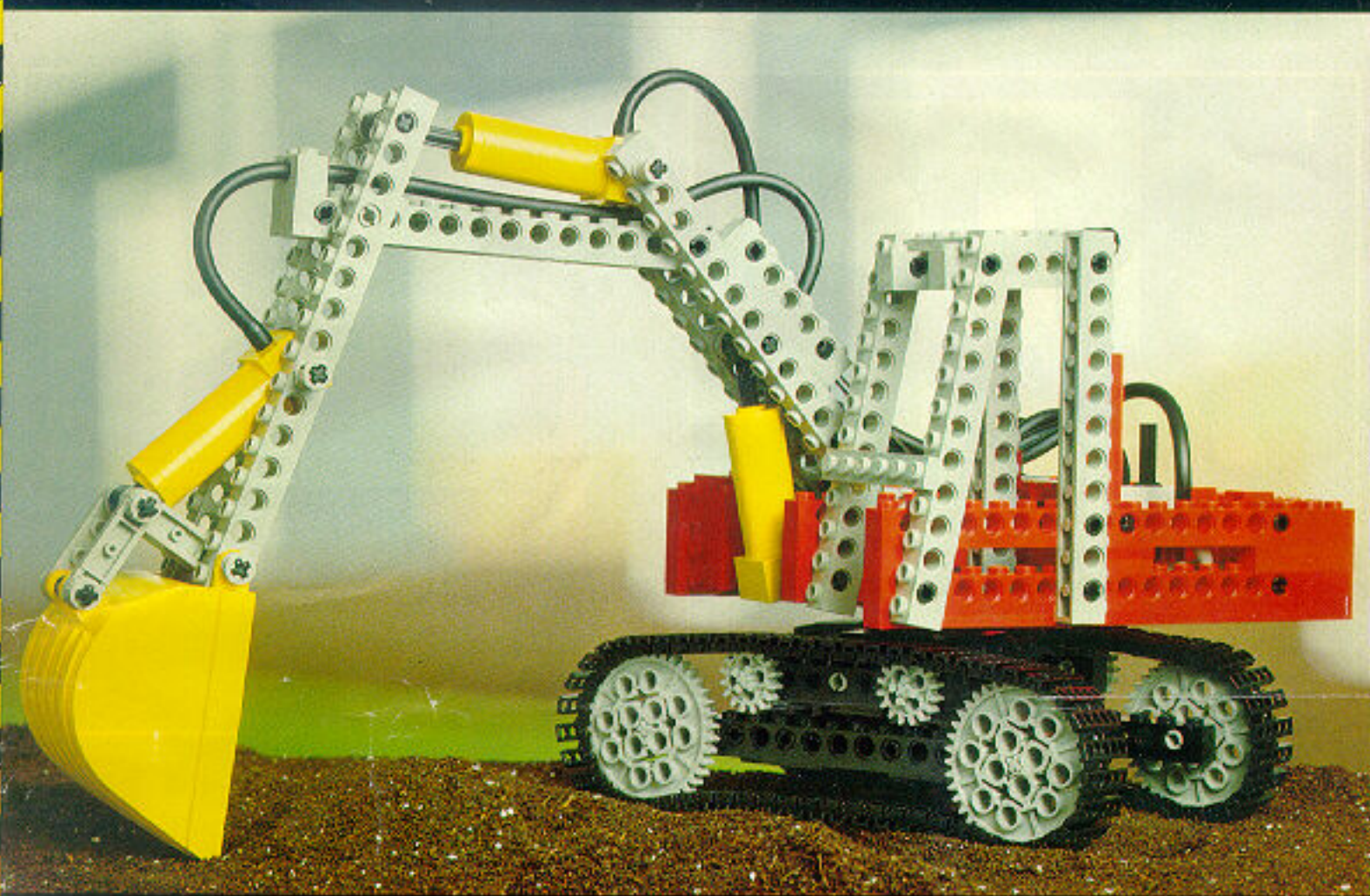

# Pneumatic

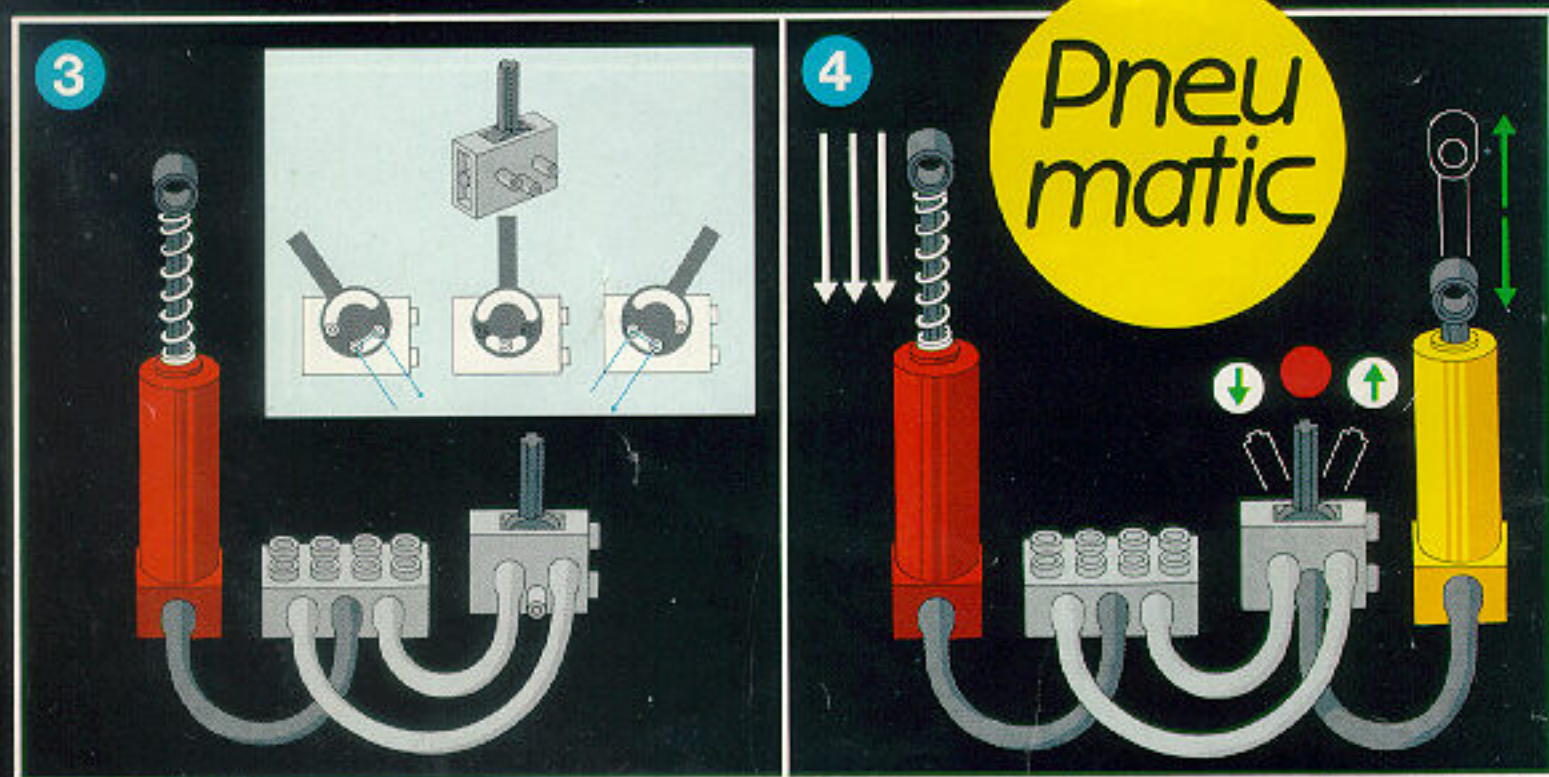
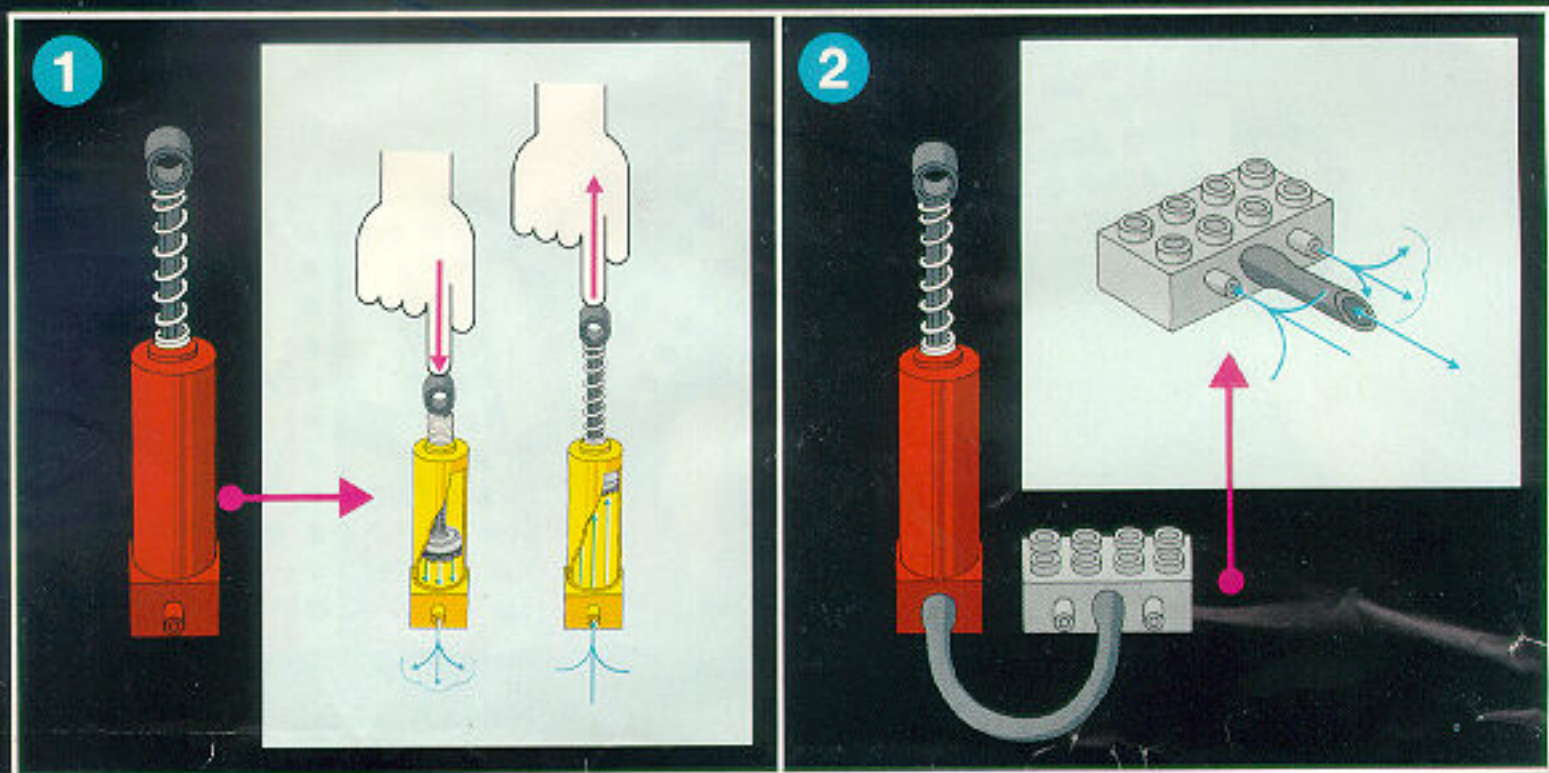



# 1

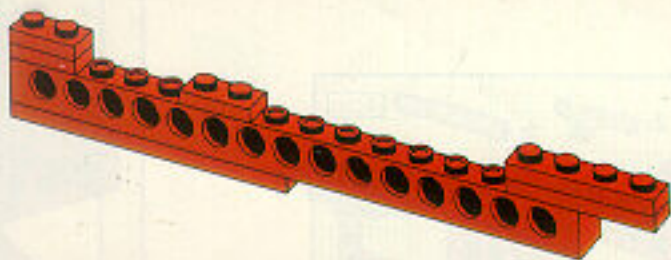
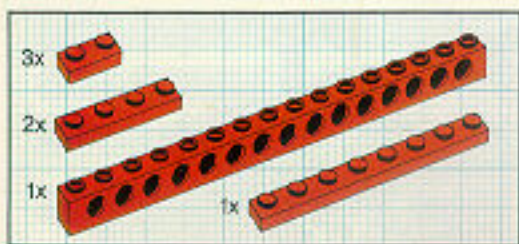

# 2

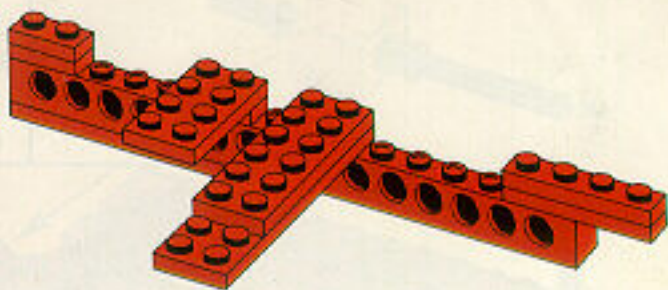
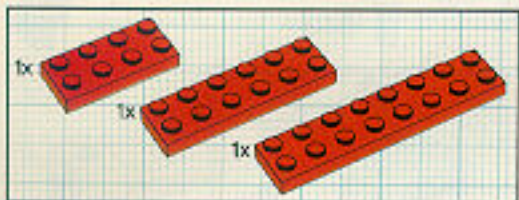

# 3

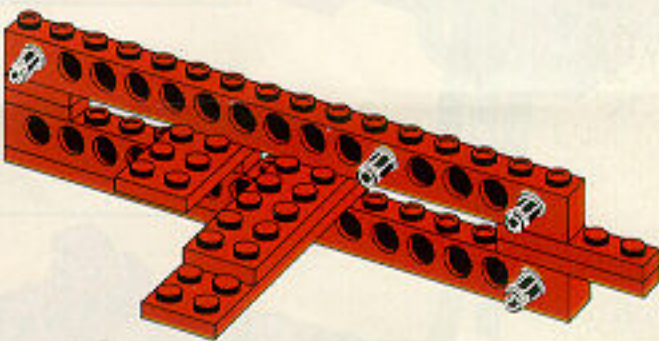

# 4

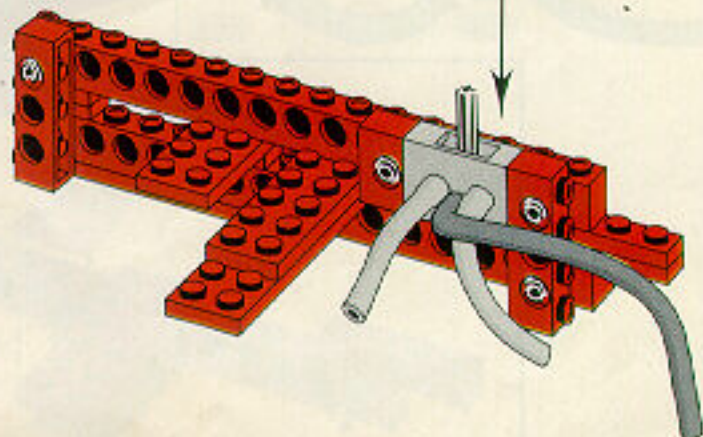
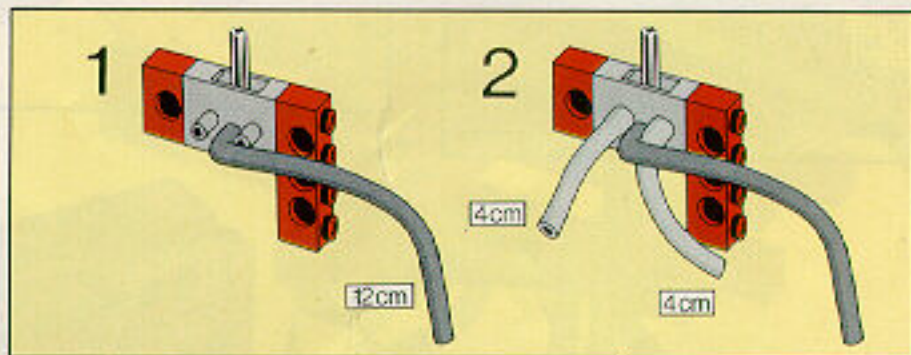
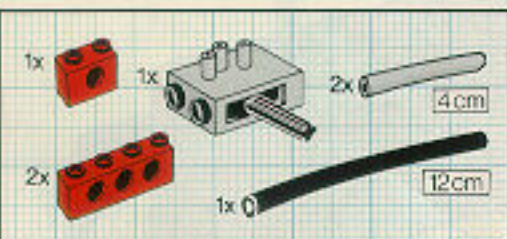



# 5

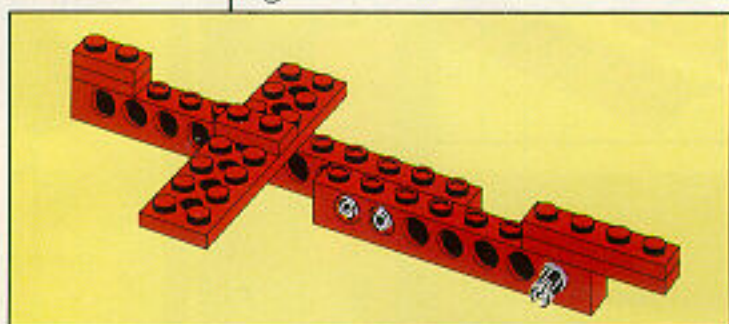
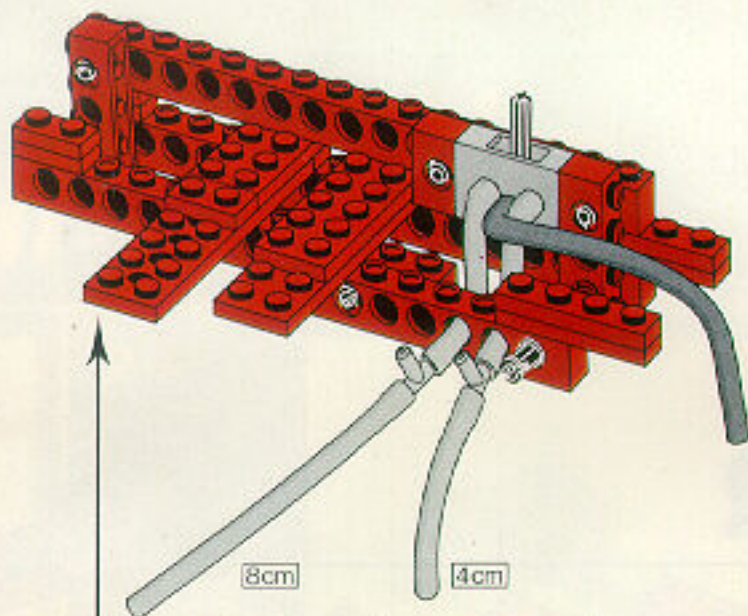
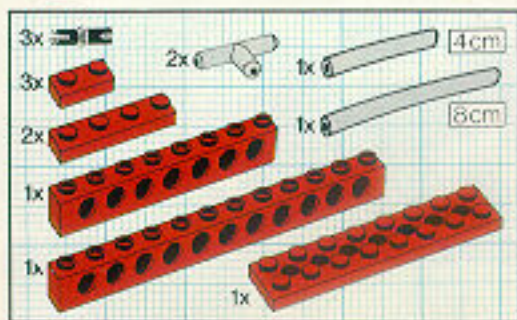

# 6

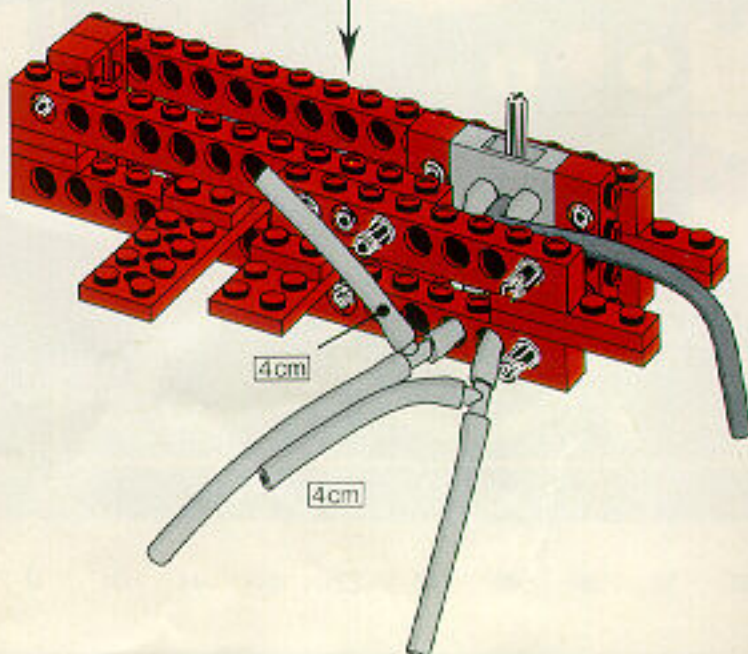
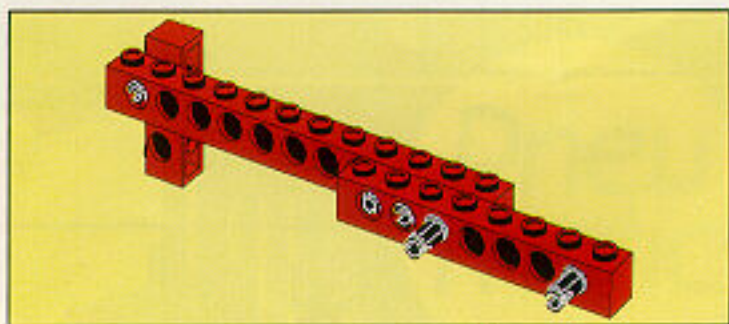
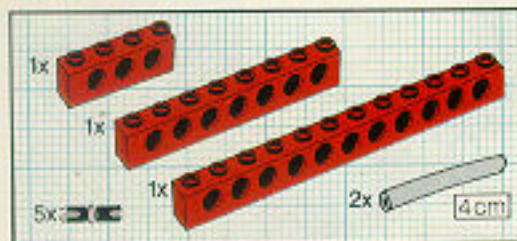







# 9

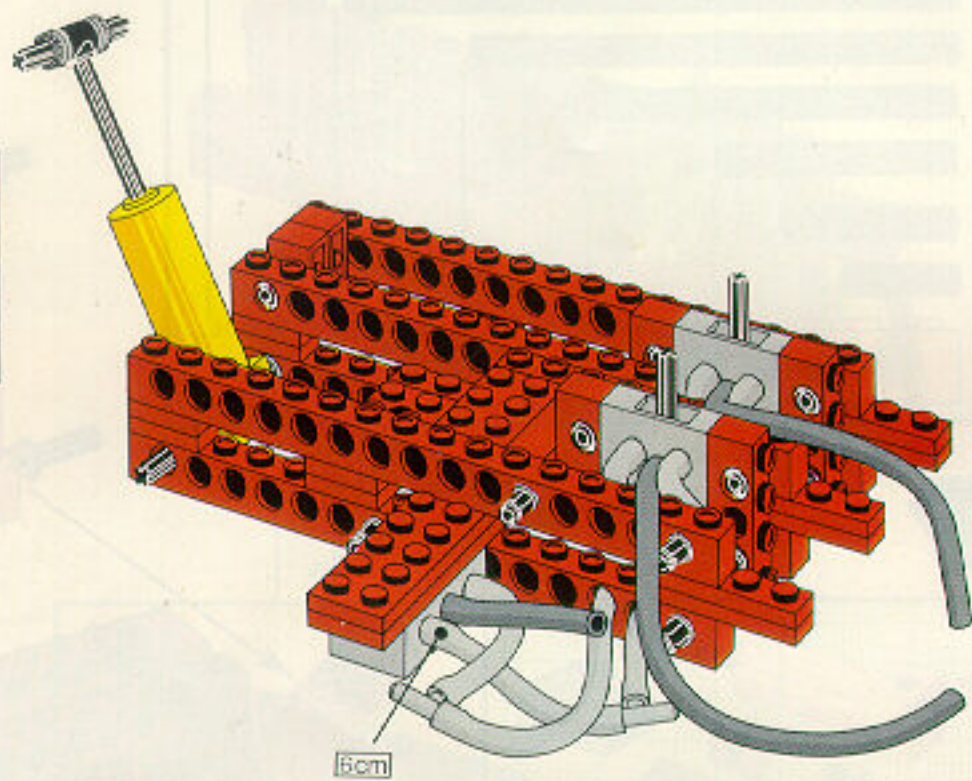
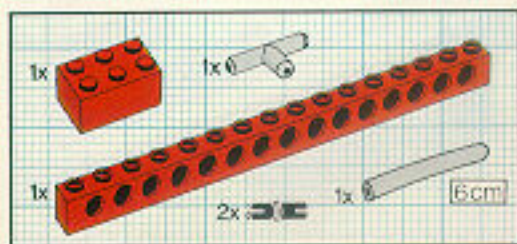

# 10

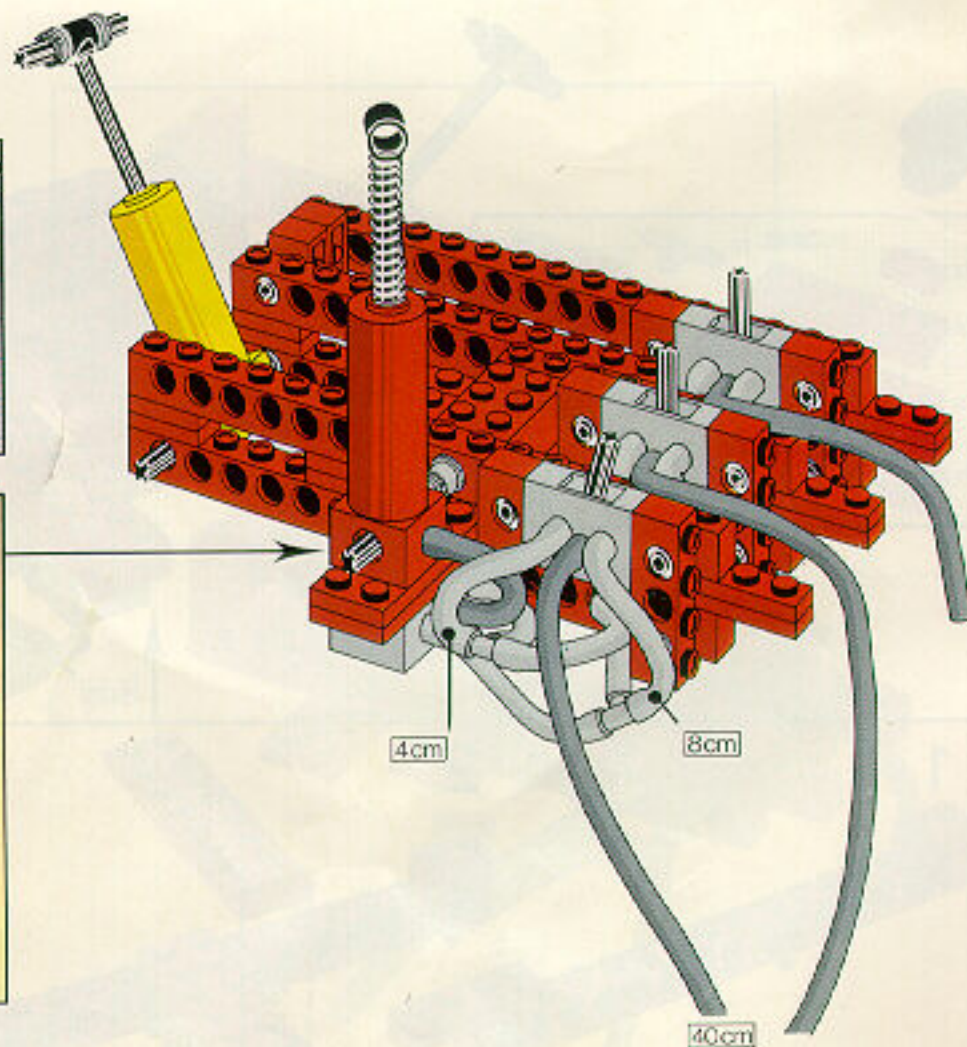
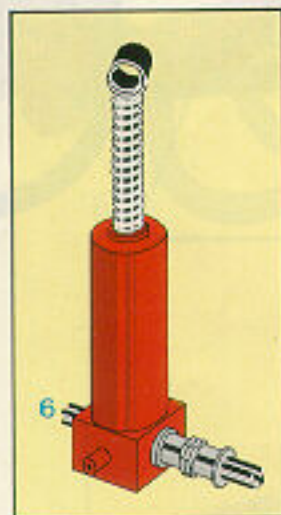
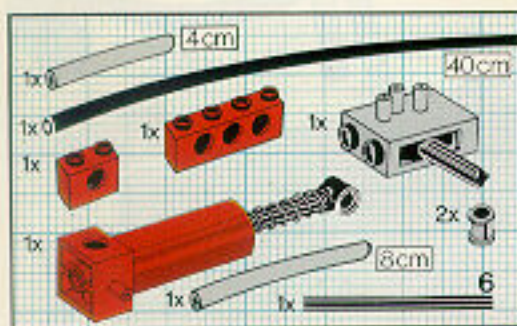



11

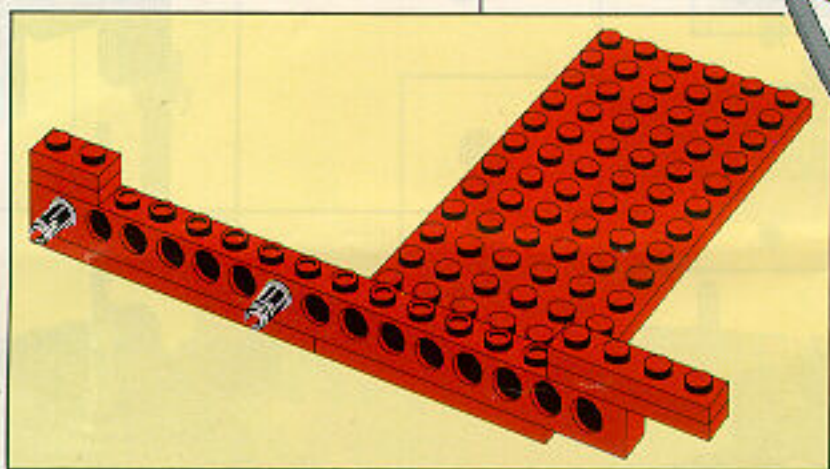
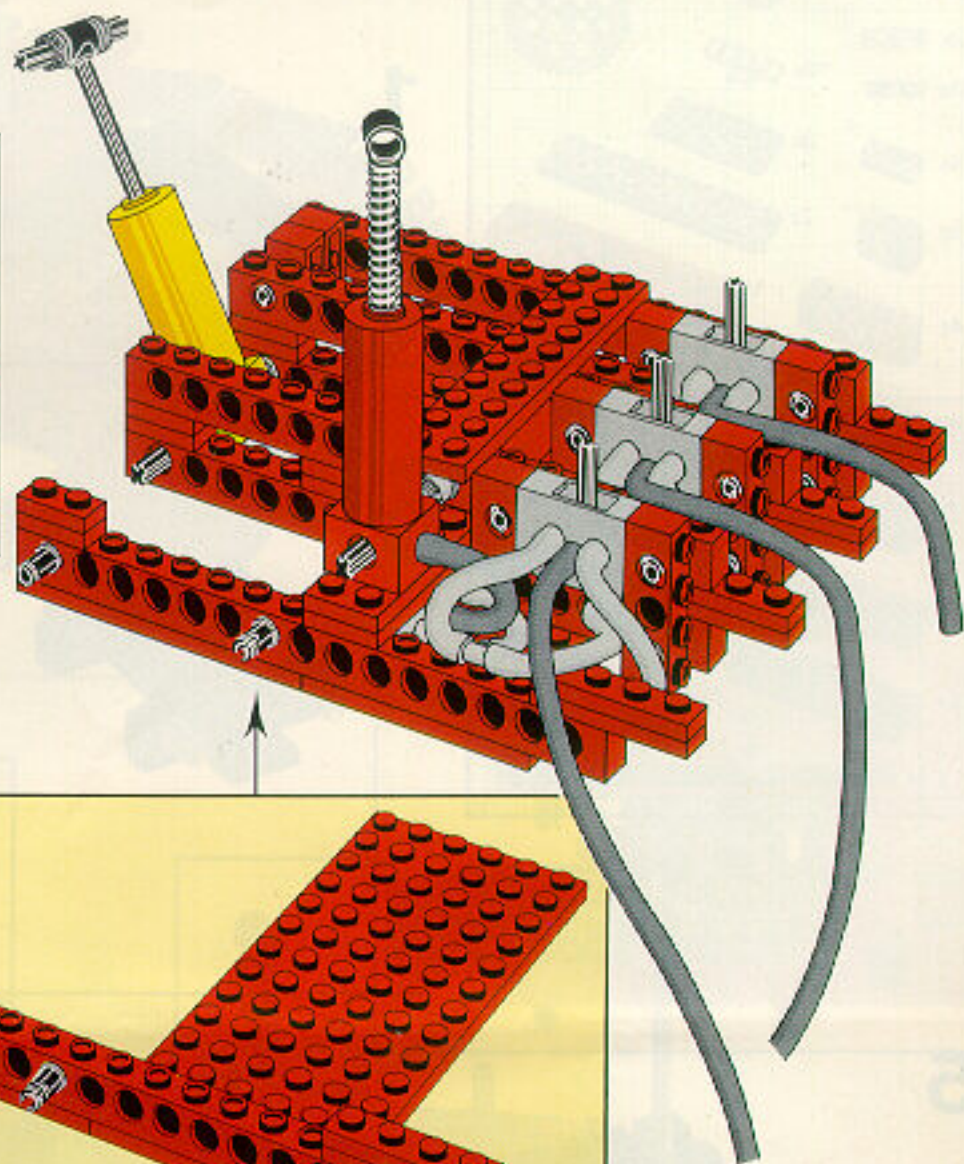
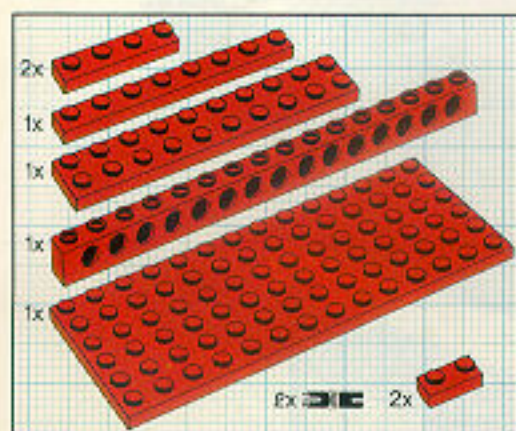

12

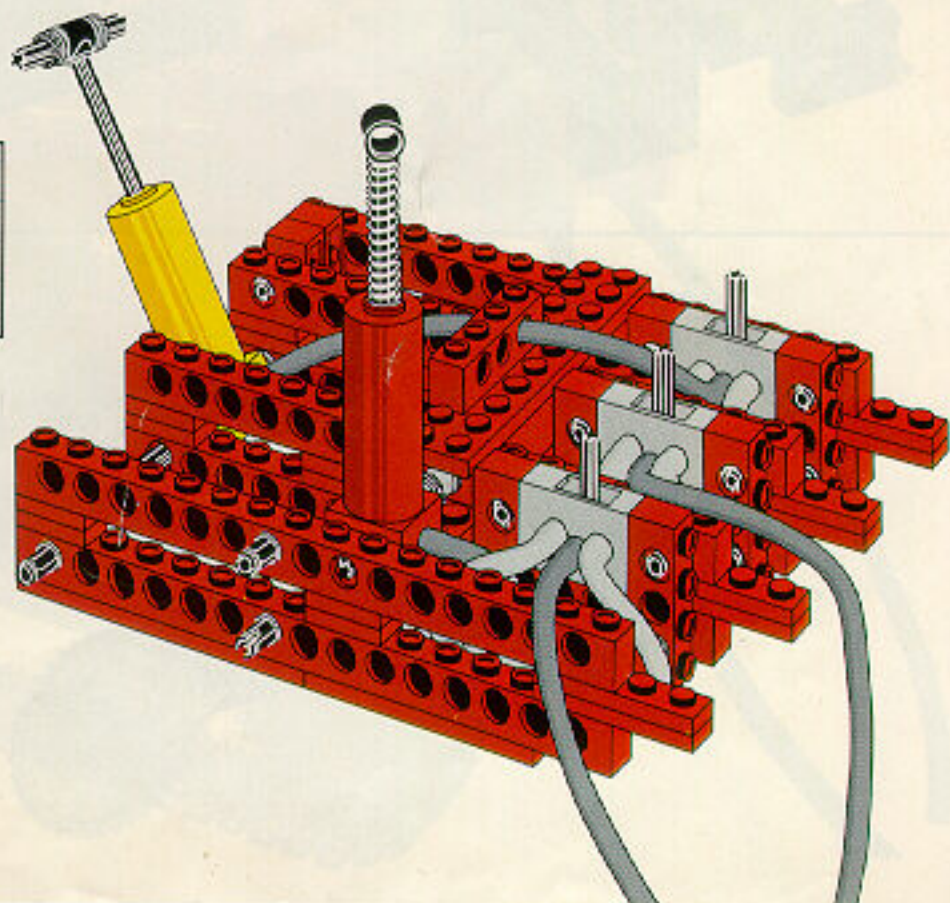
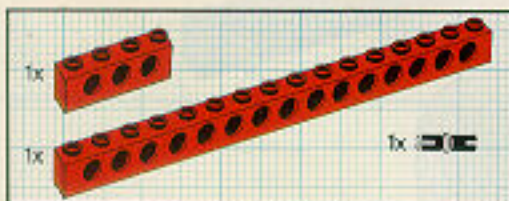







8

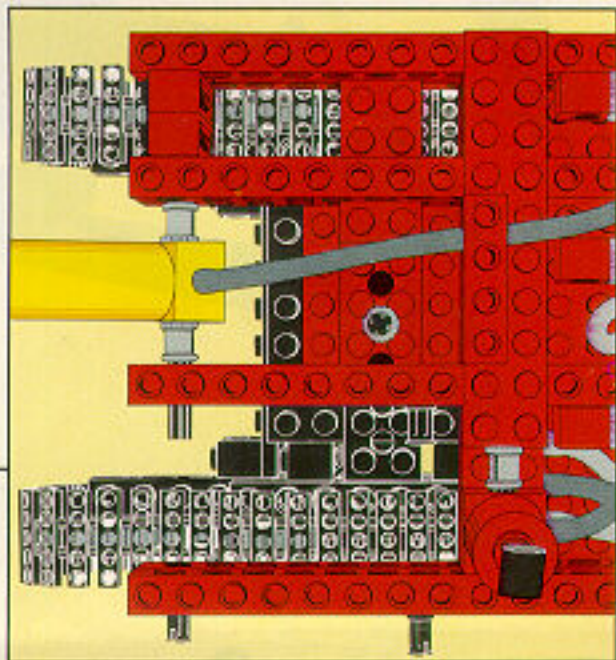
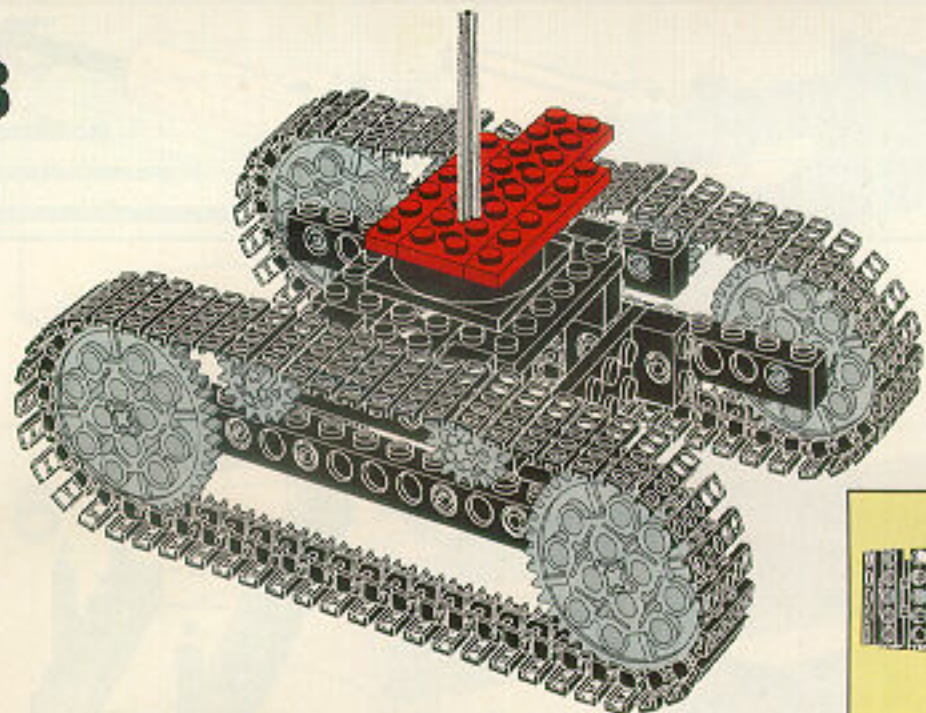

13

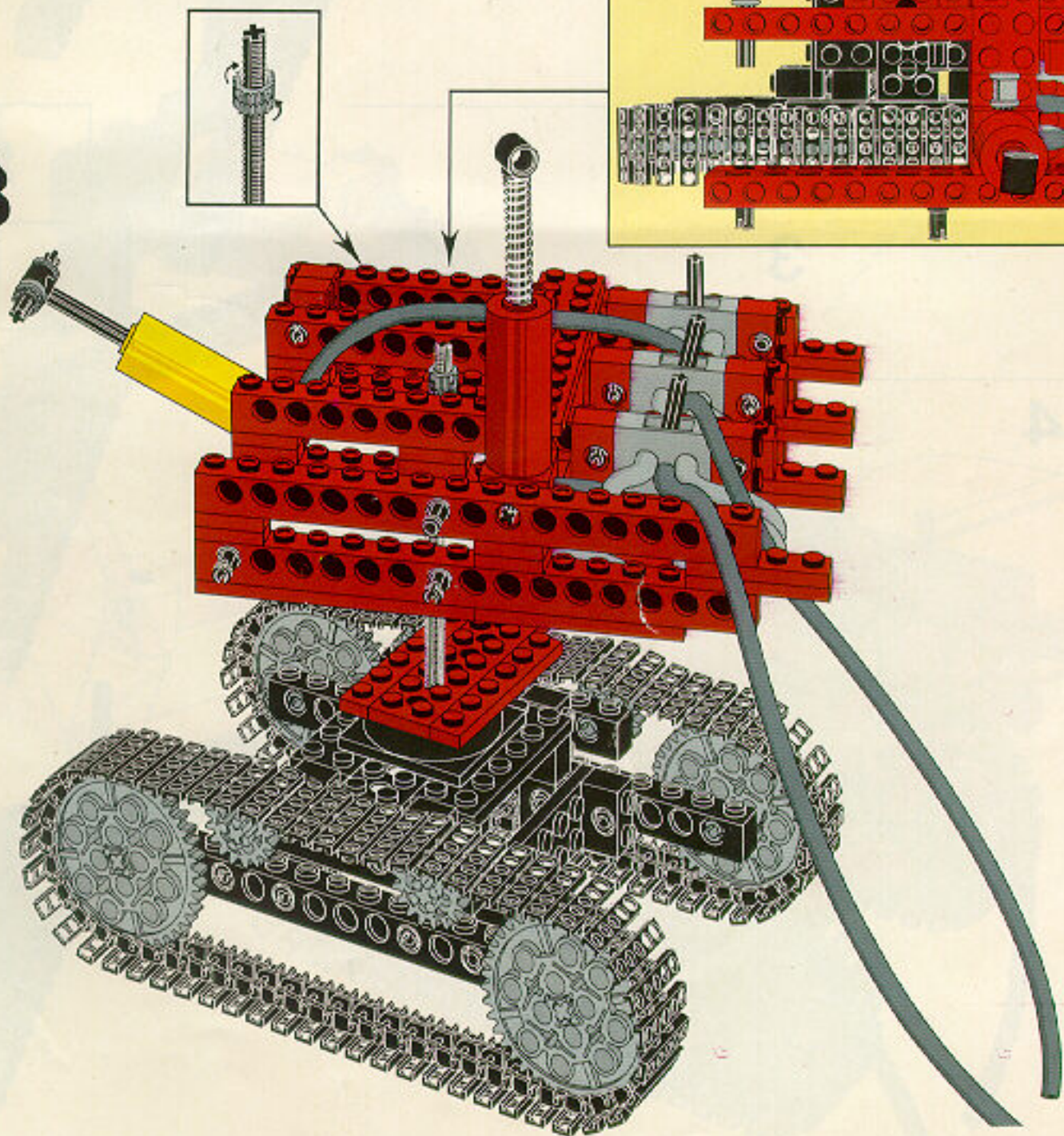



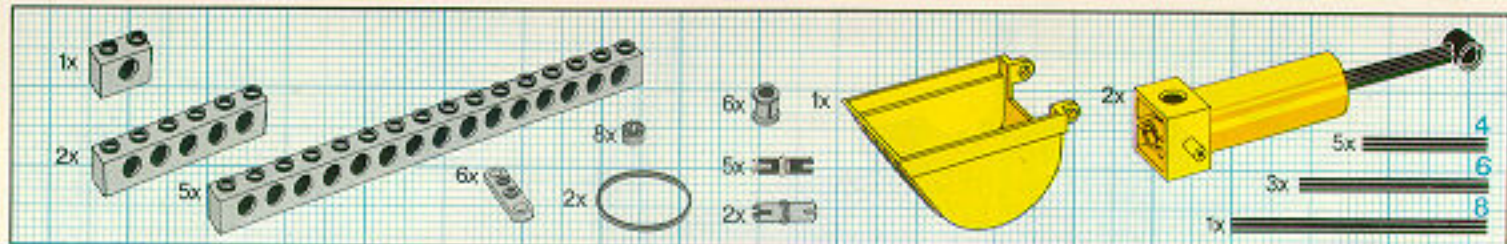

1

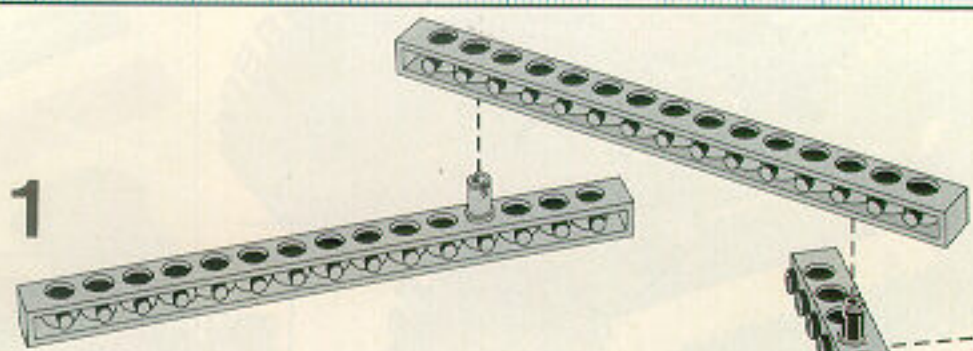

2

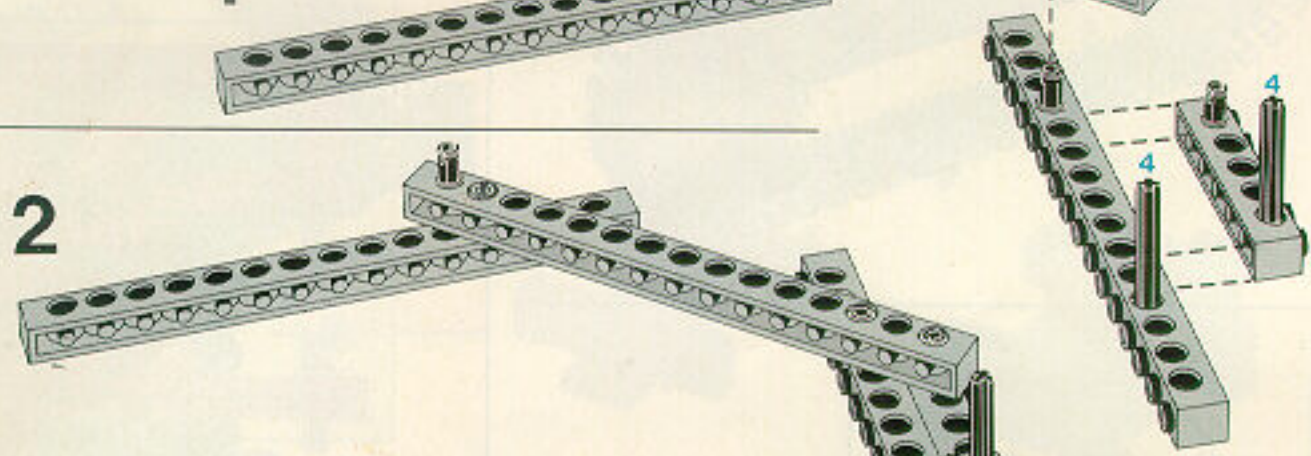

3

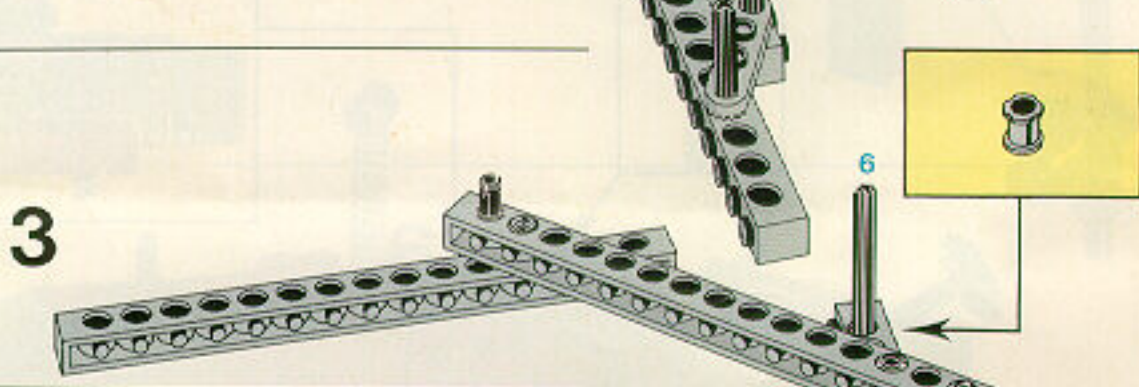

4

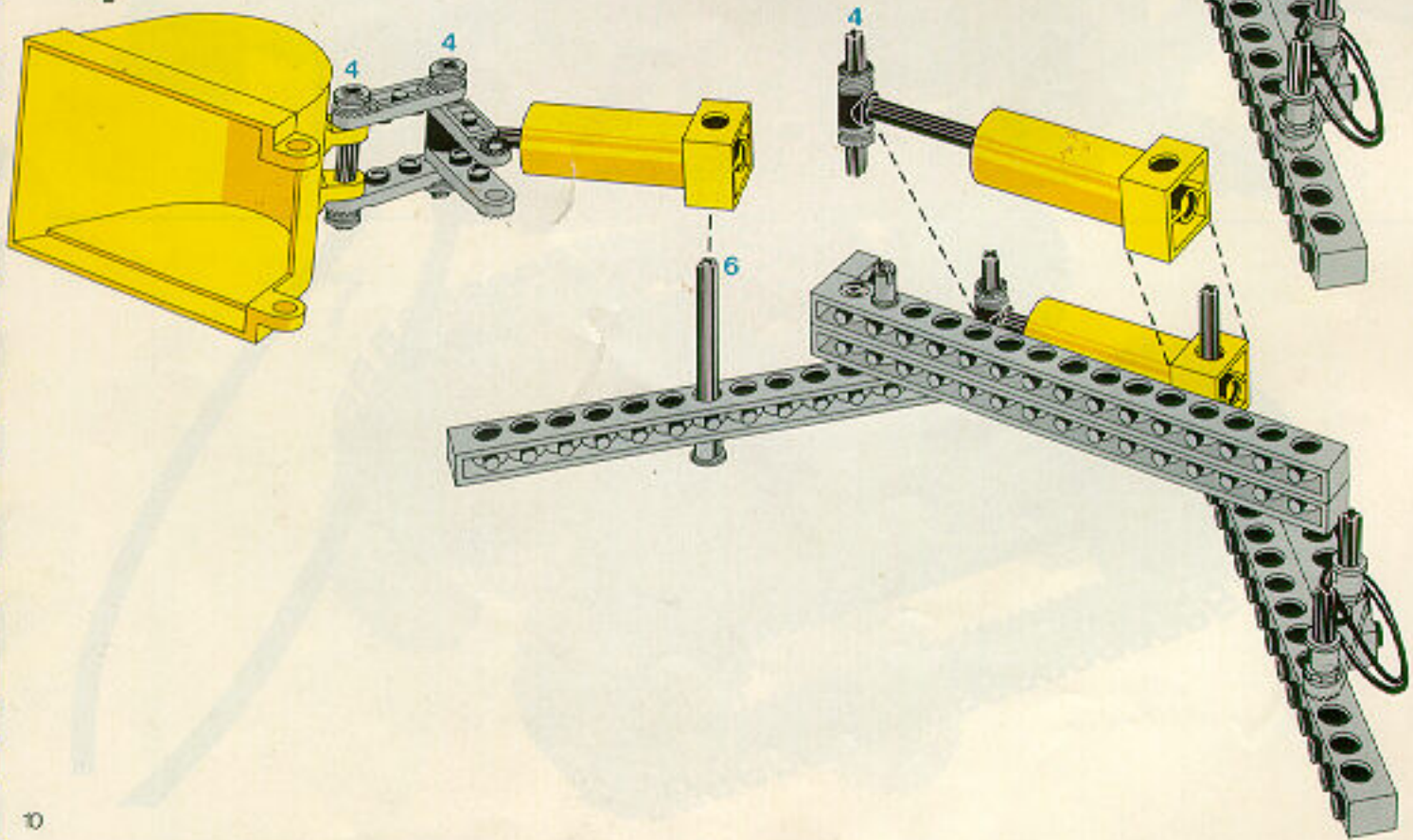



5

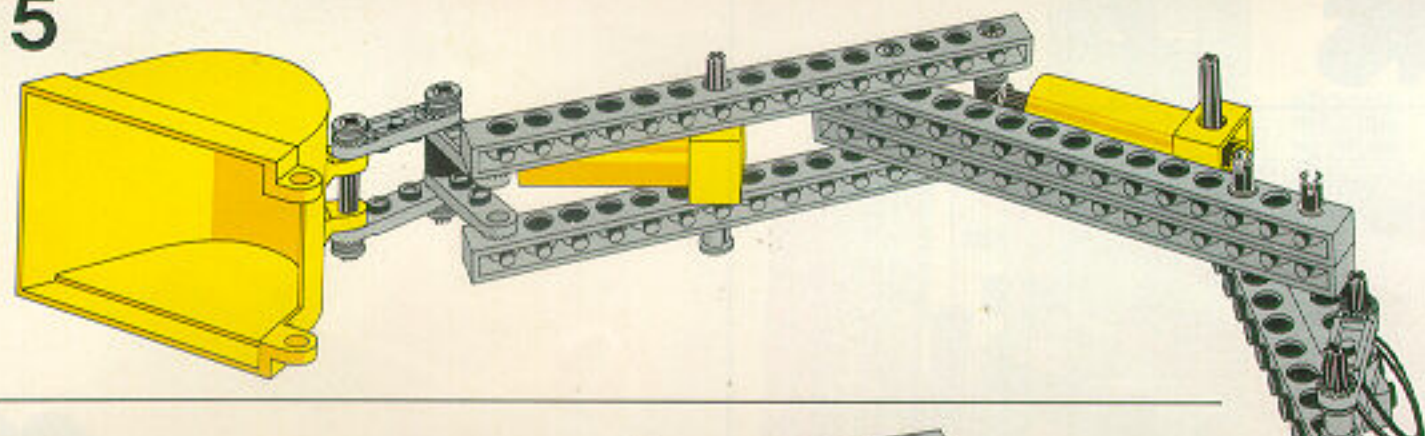

6

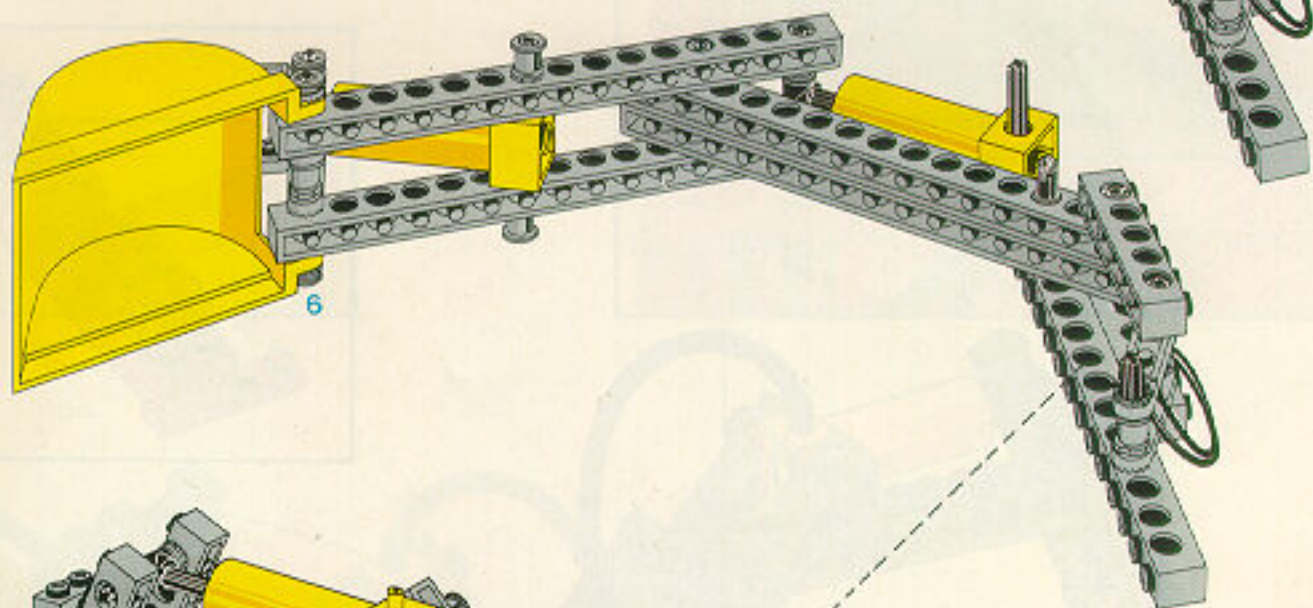

14

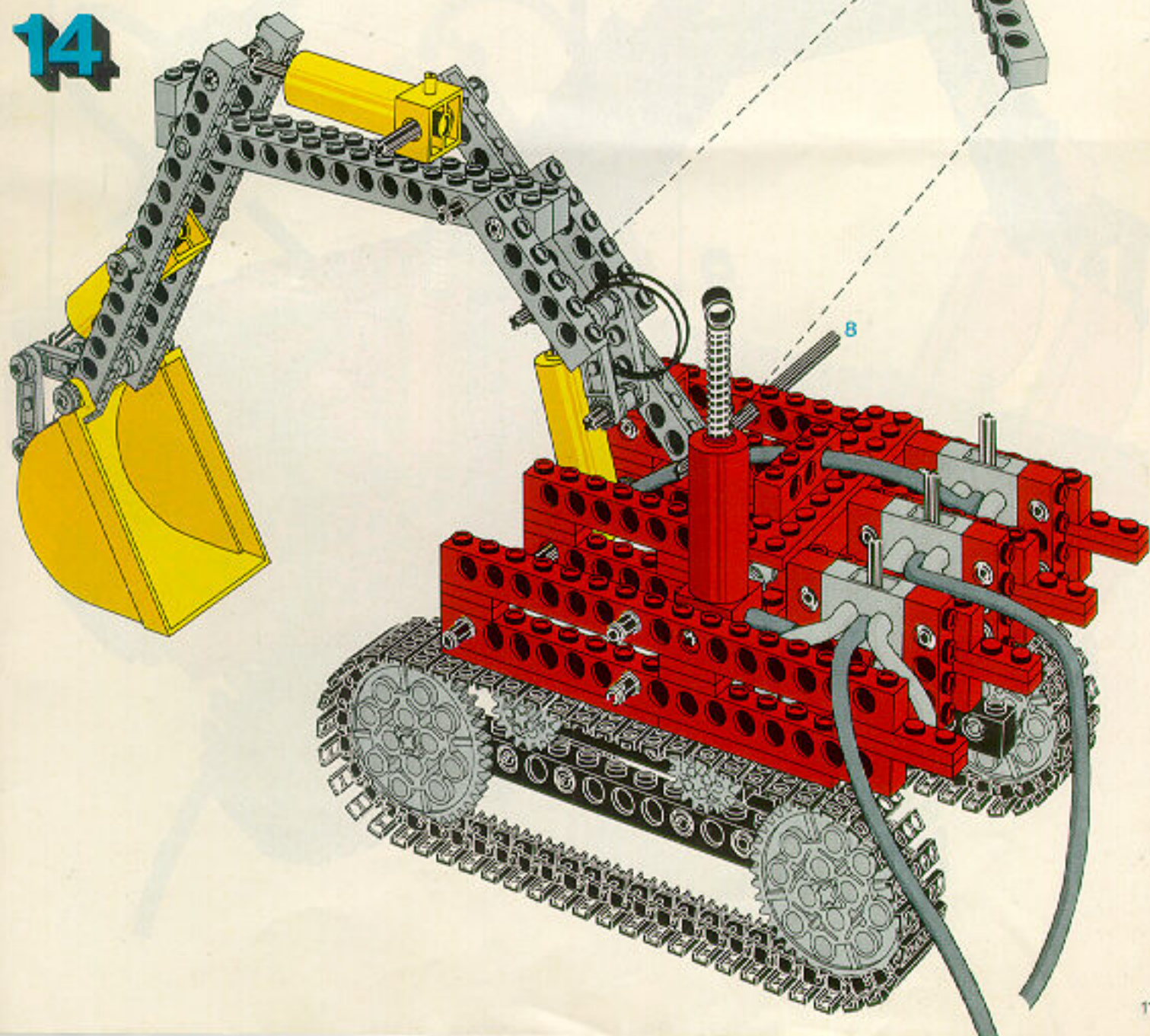



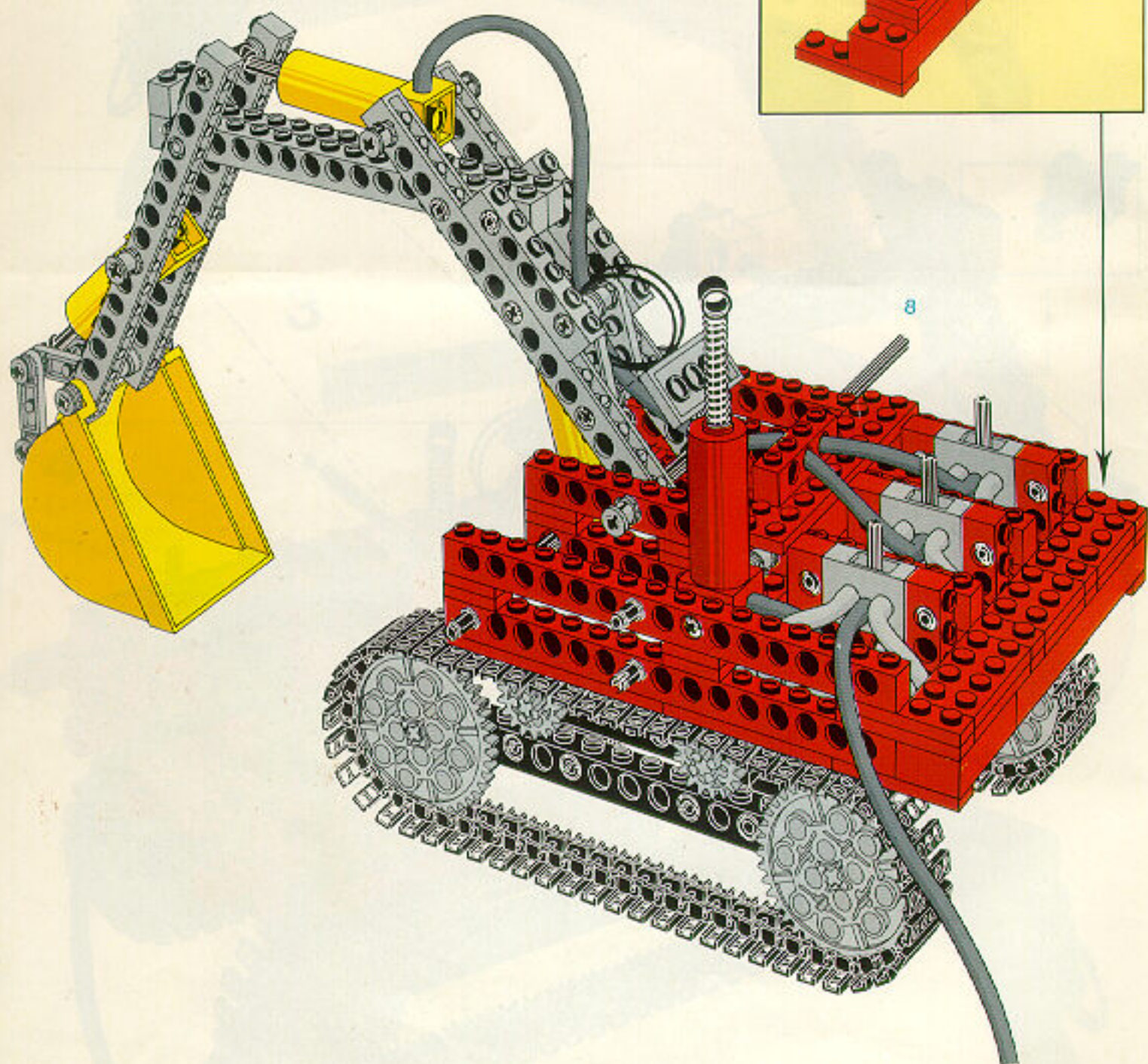
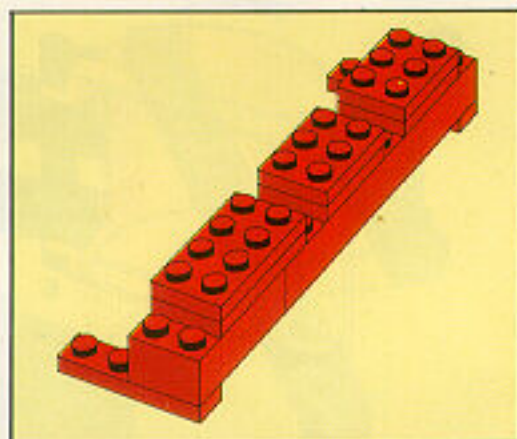
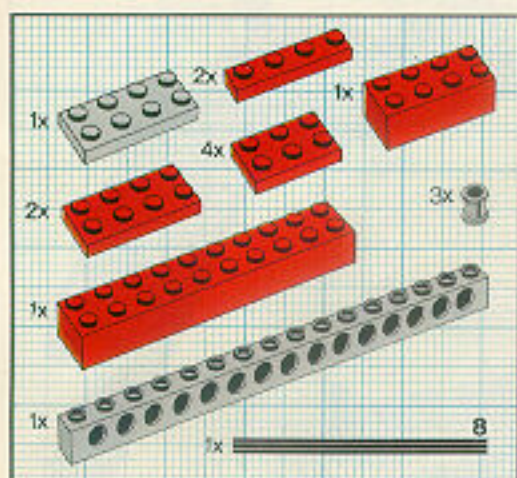



# 16

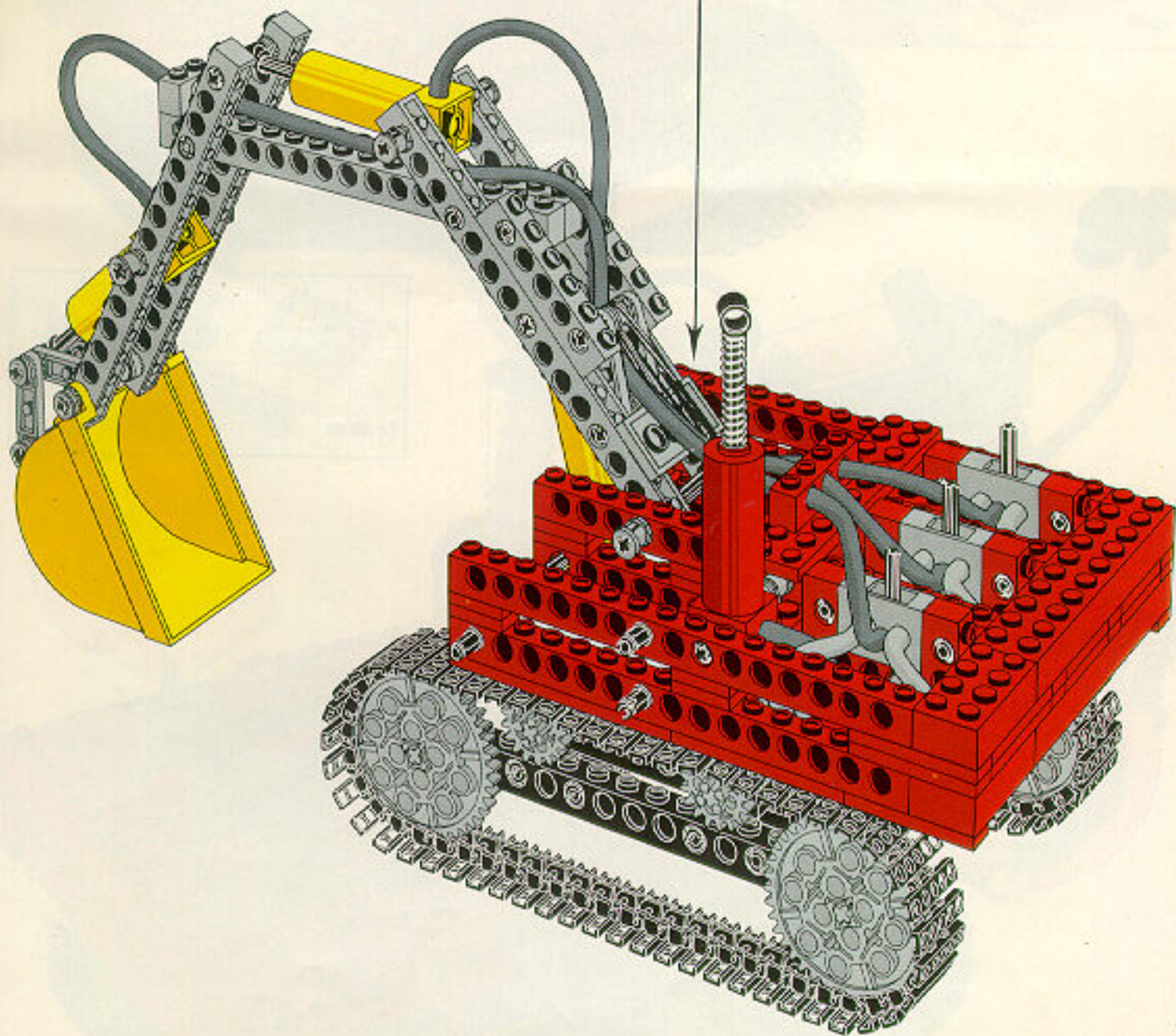
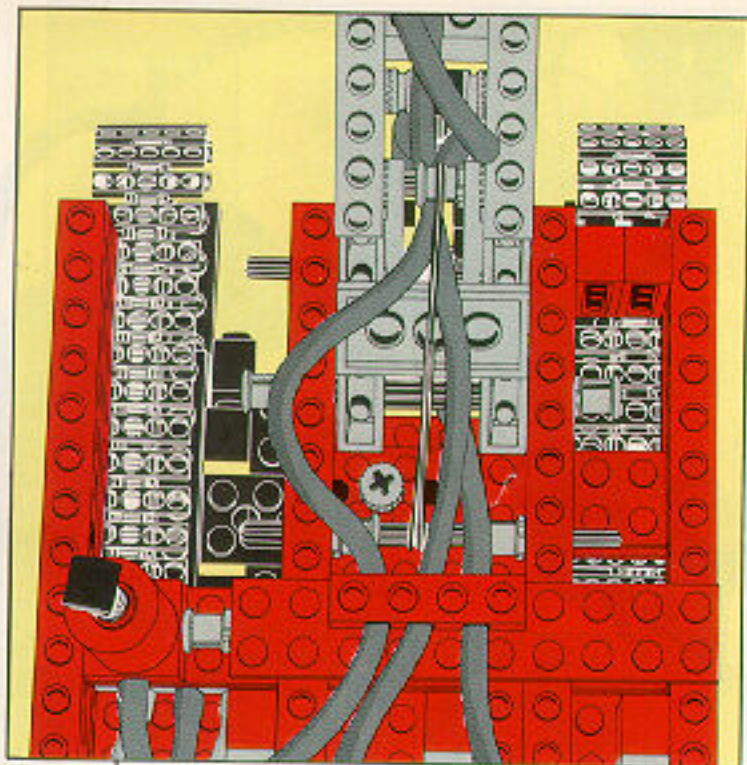
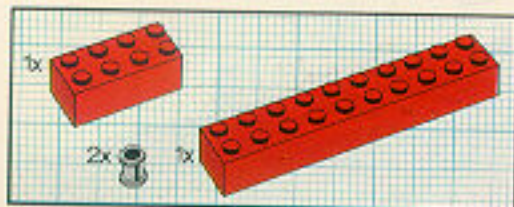

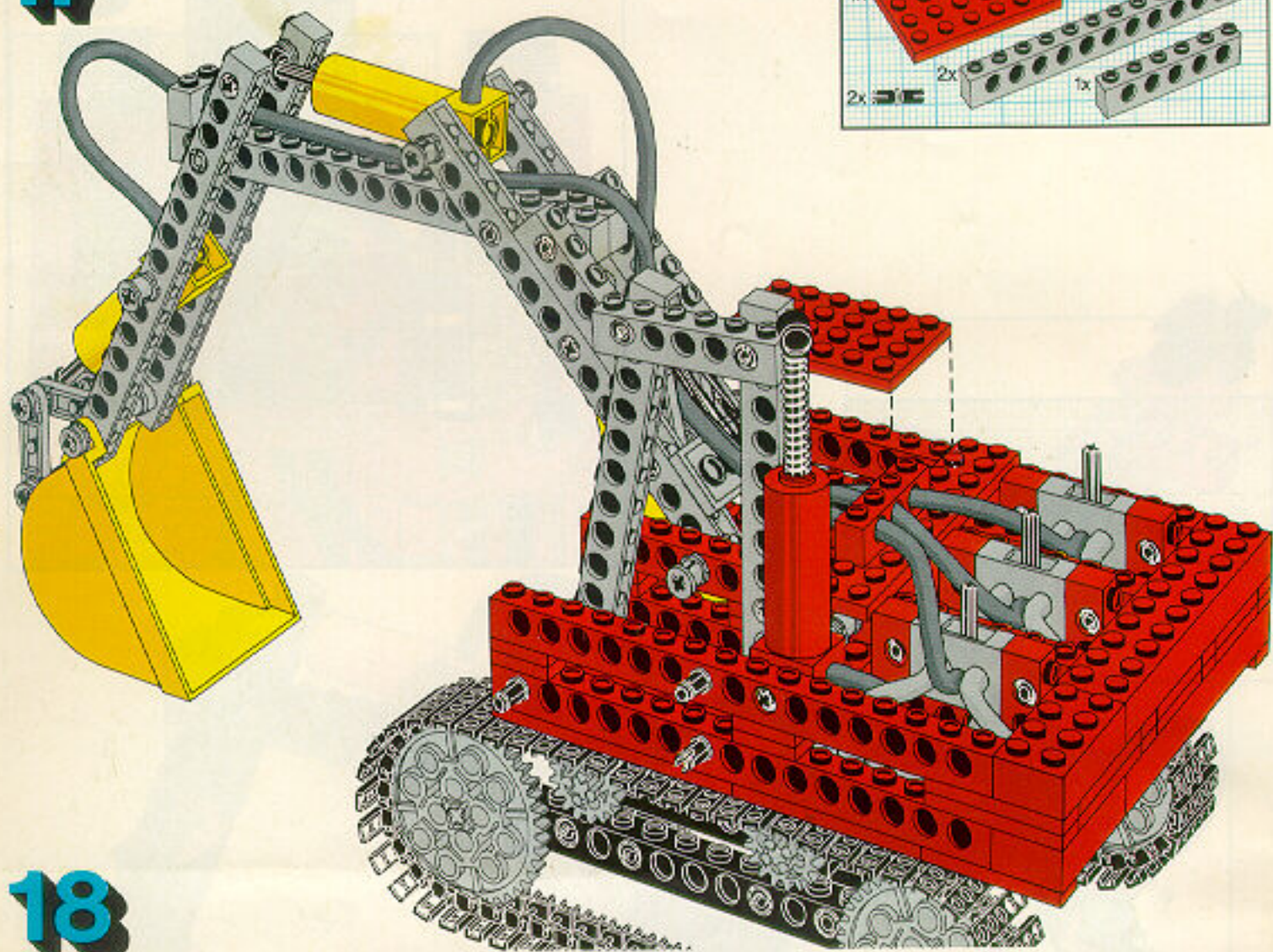
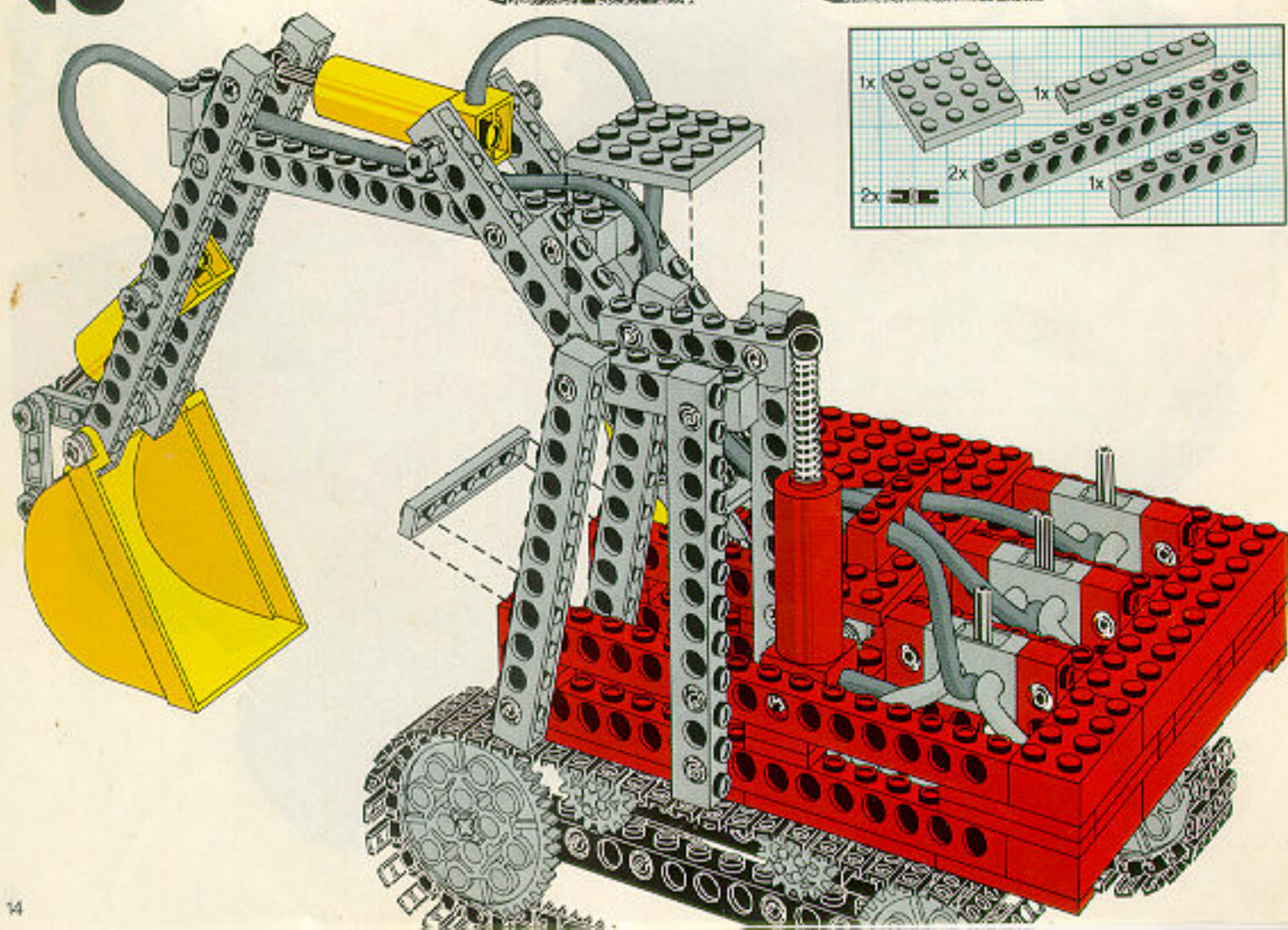

**17****18**



19

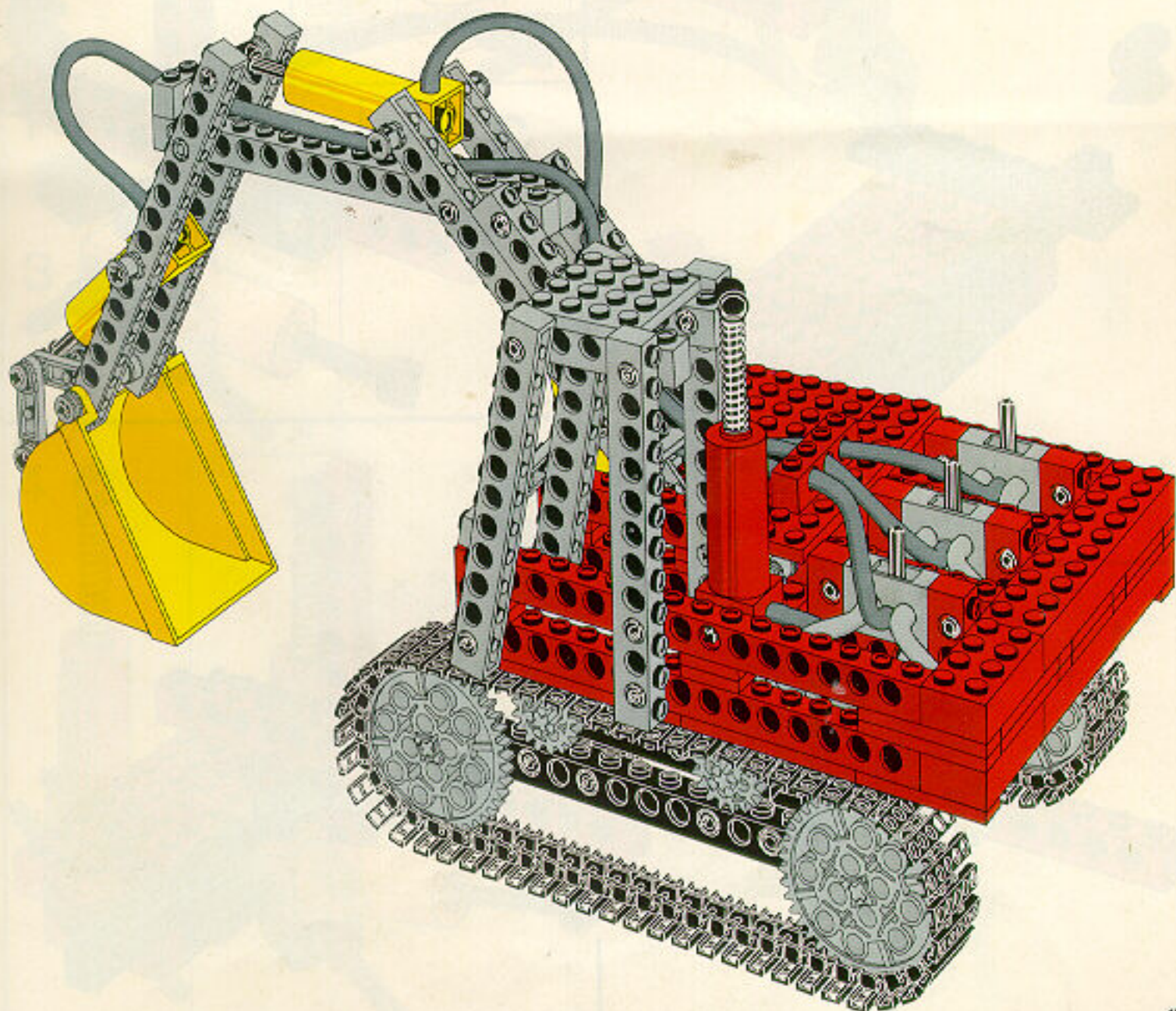
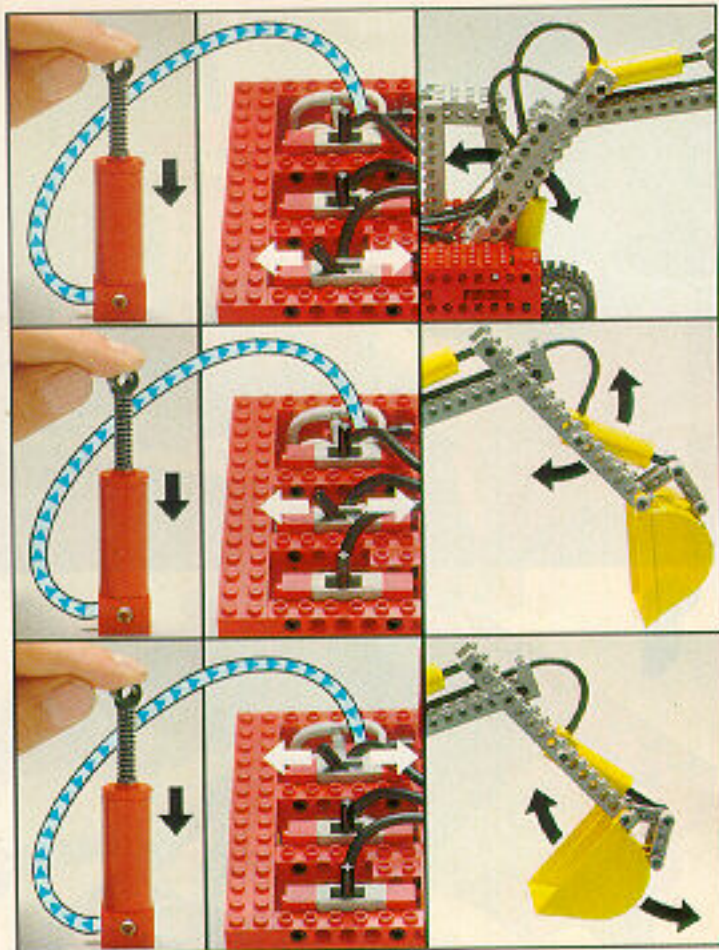





2

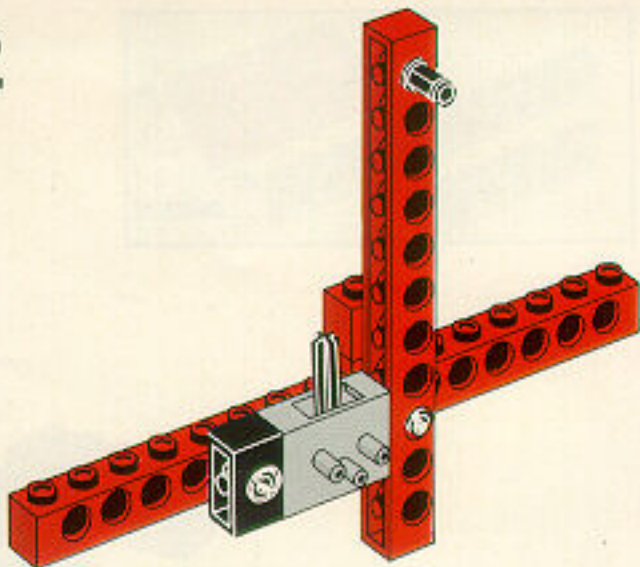

1

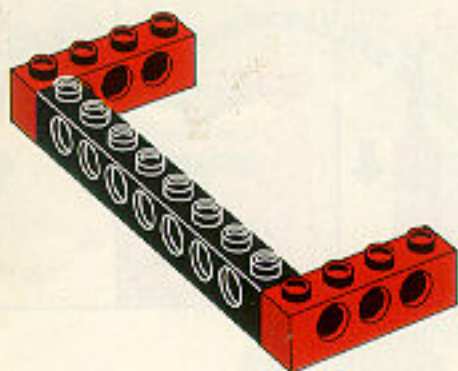

2

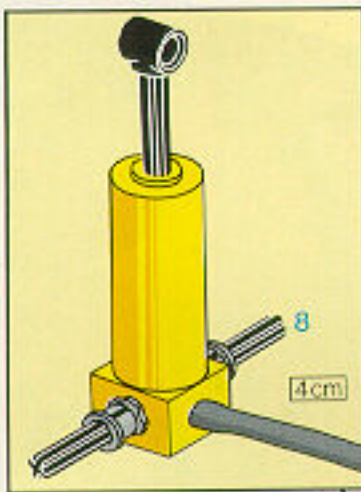
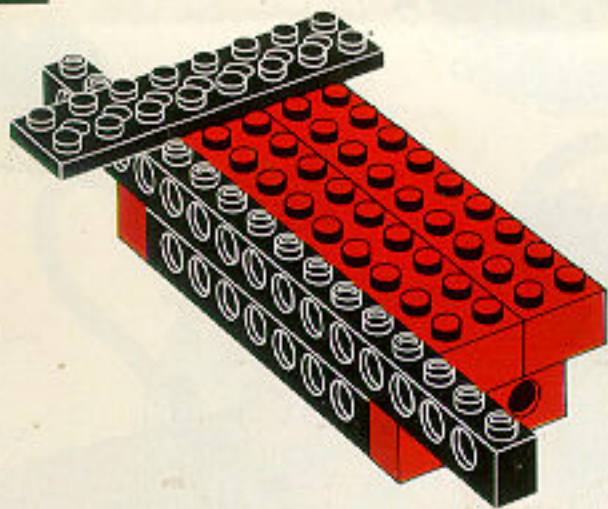

3

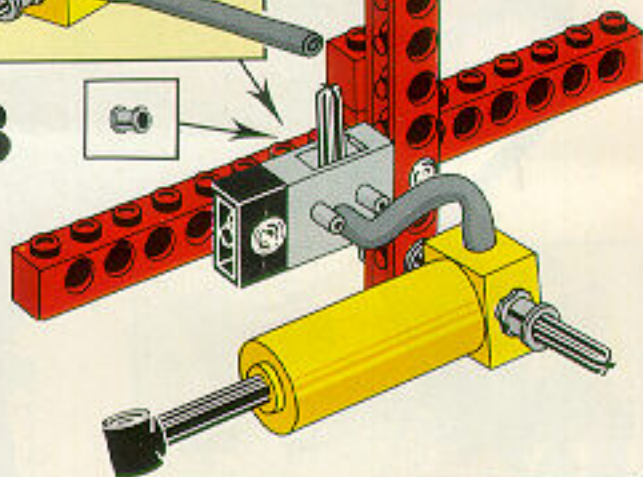

3

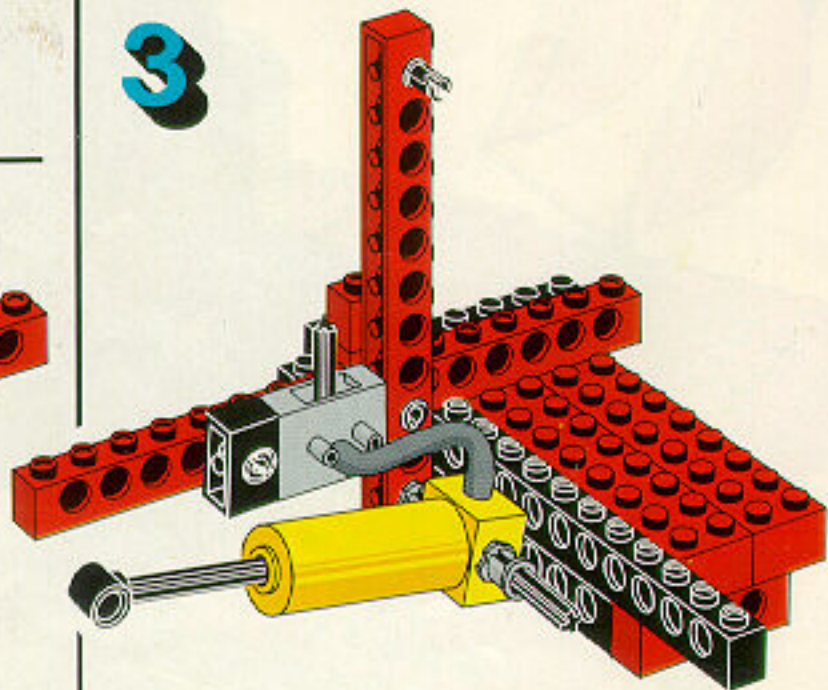

1

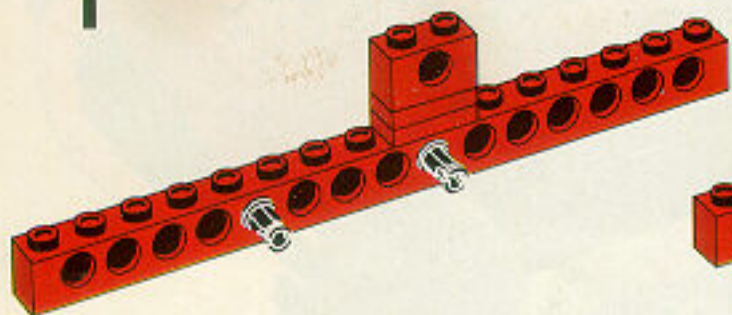



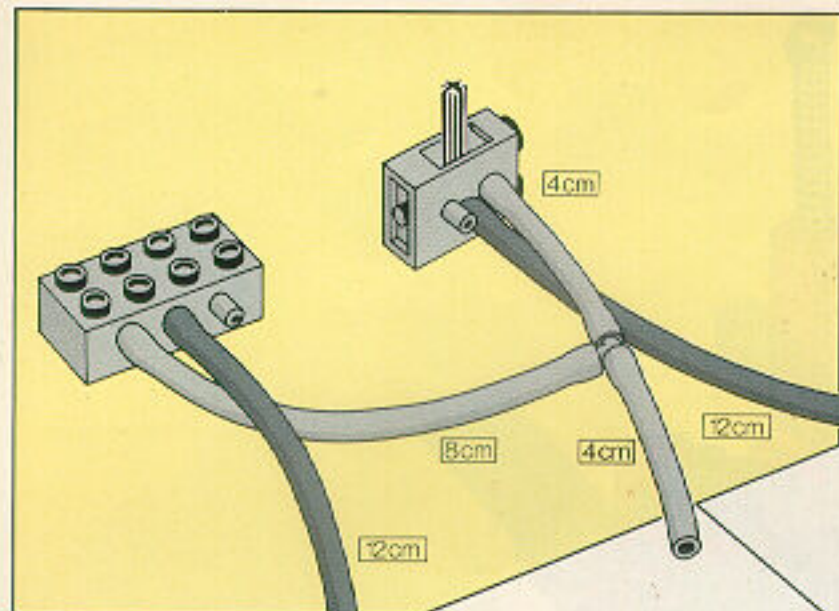

4

5

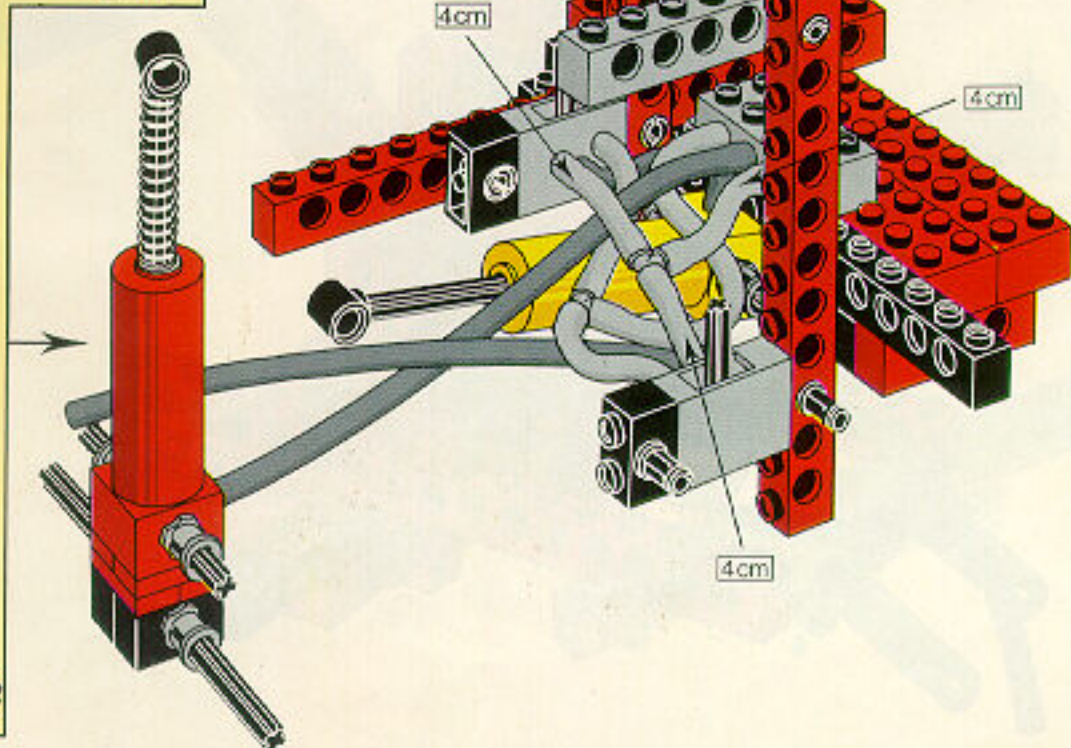
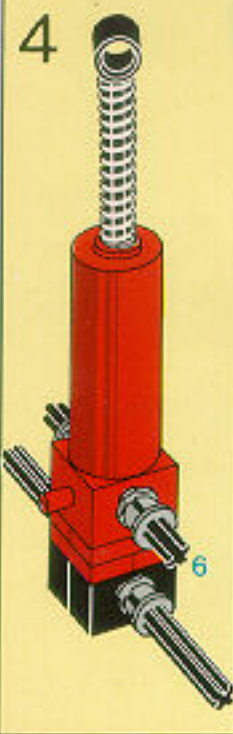
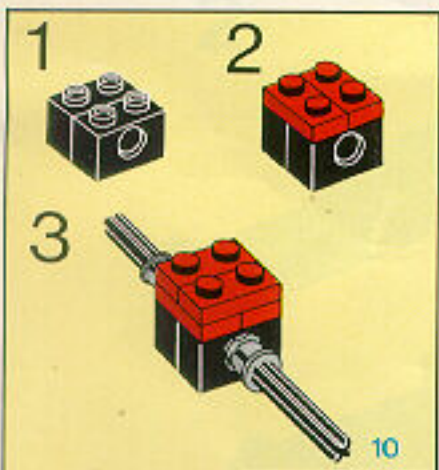
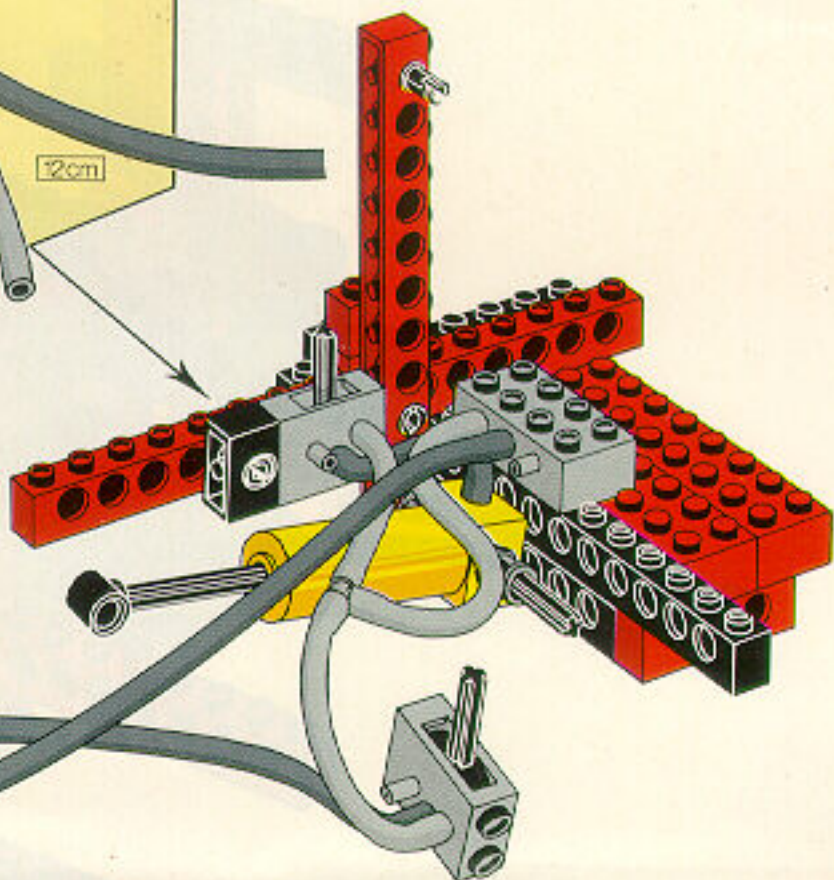



6

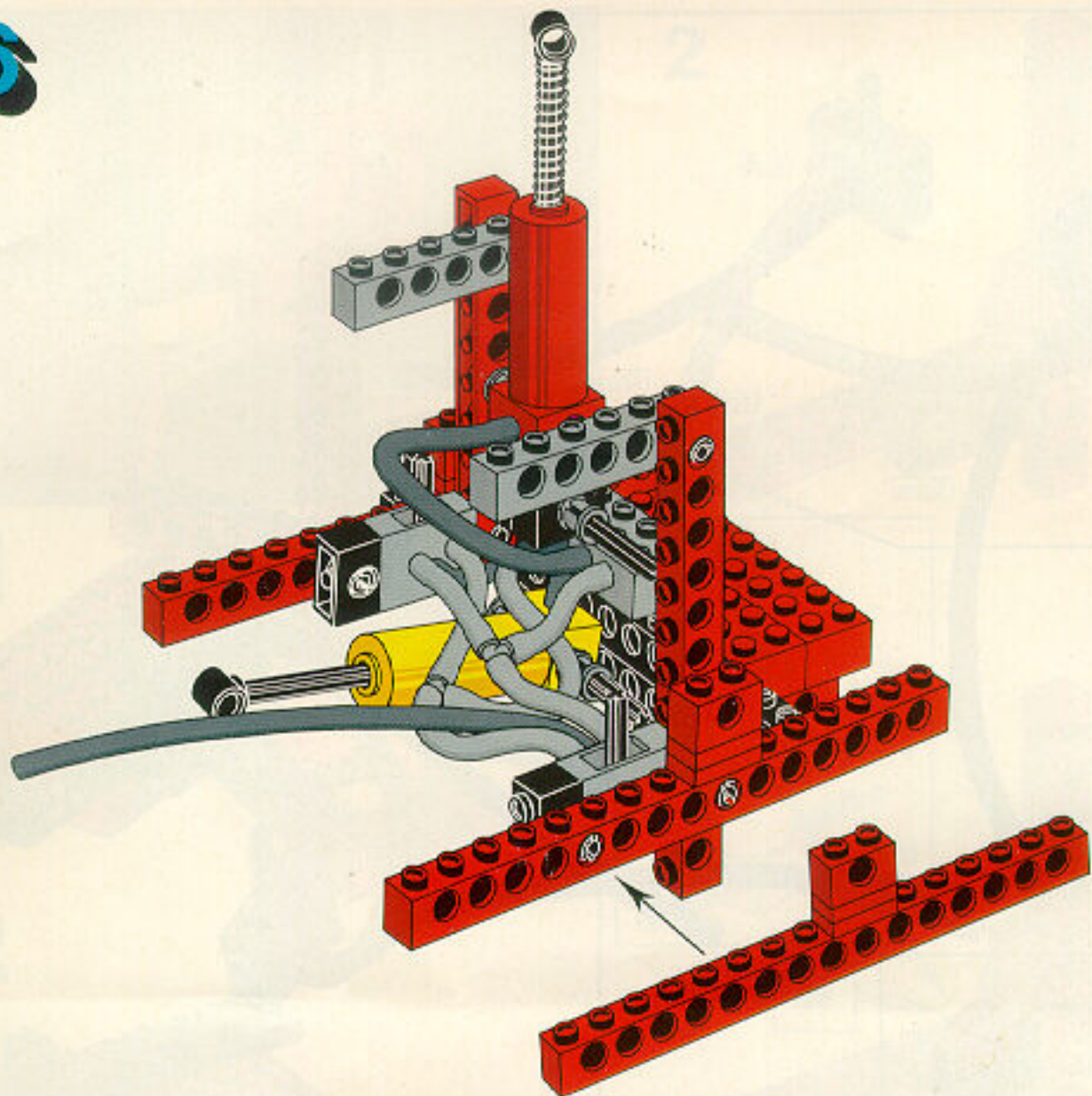

7

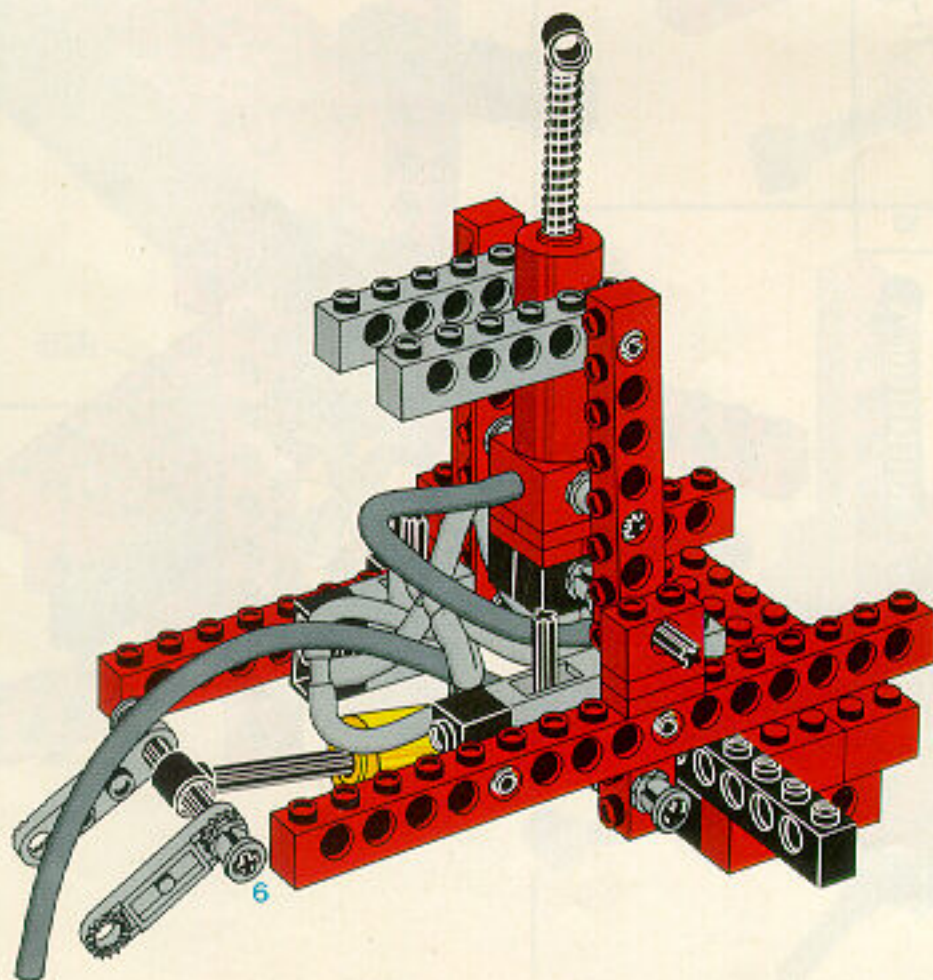



1

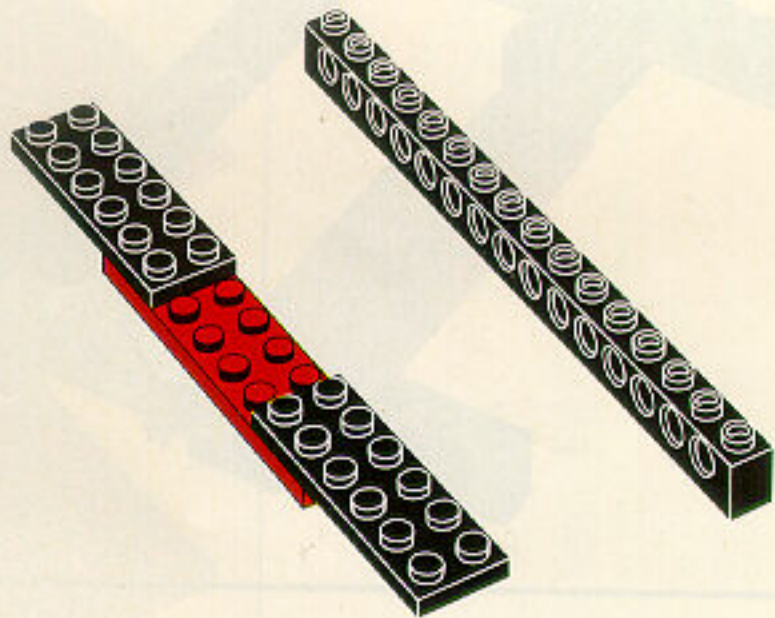

2

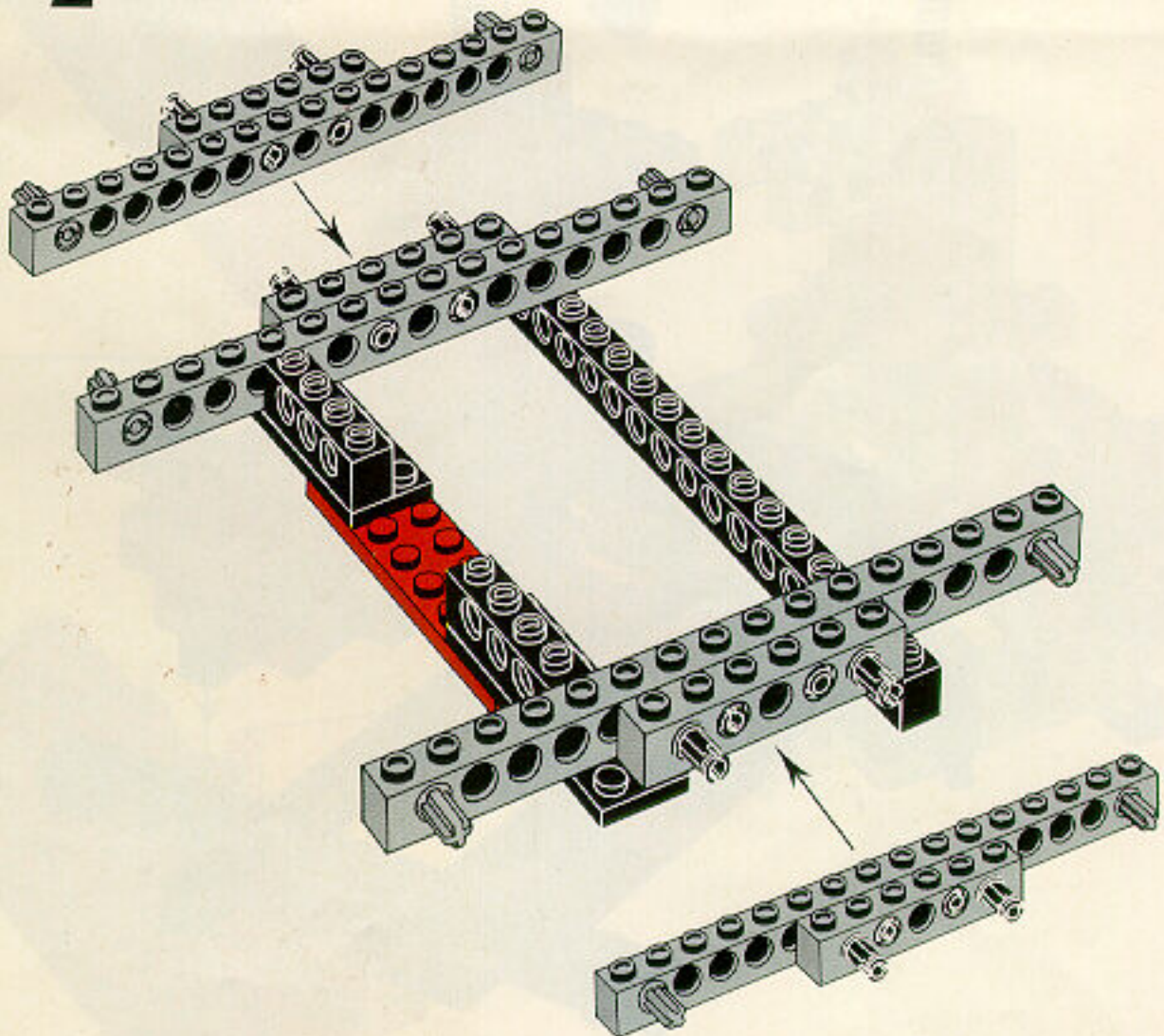



3

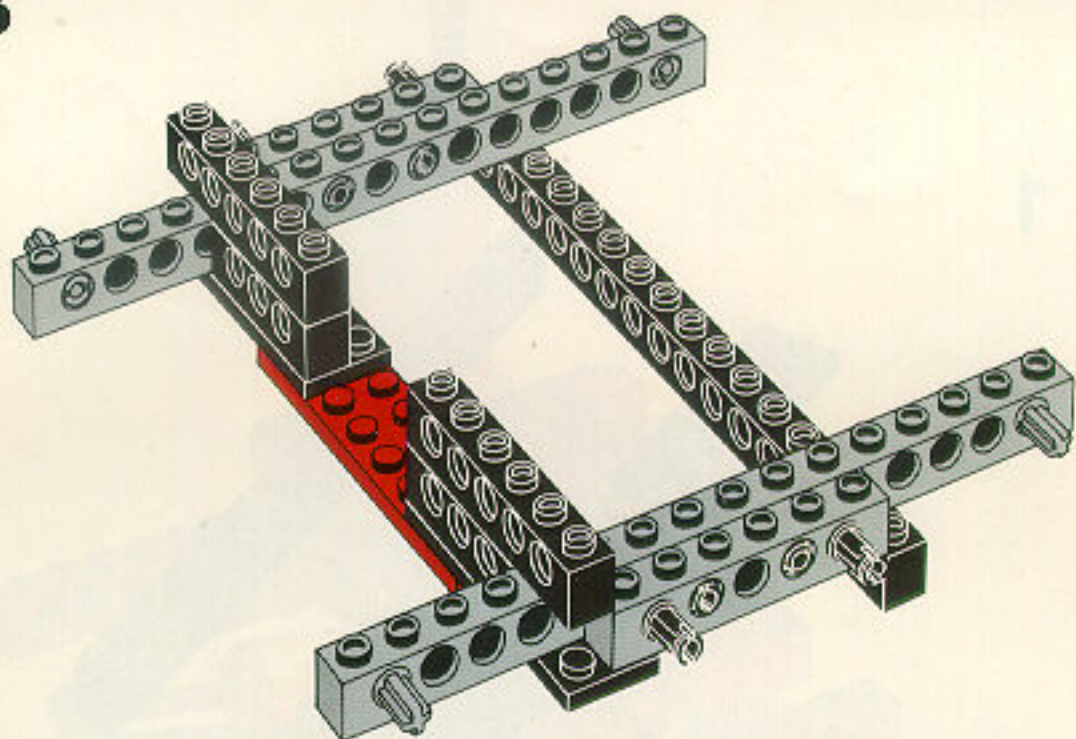

8

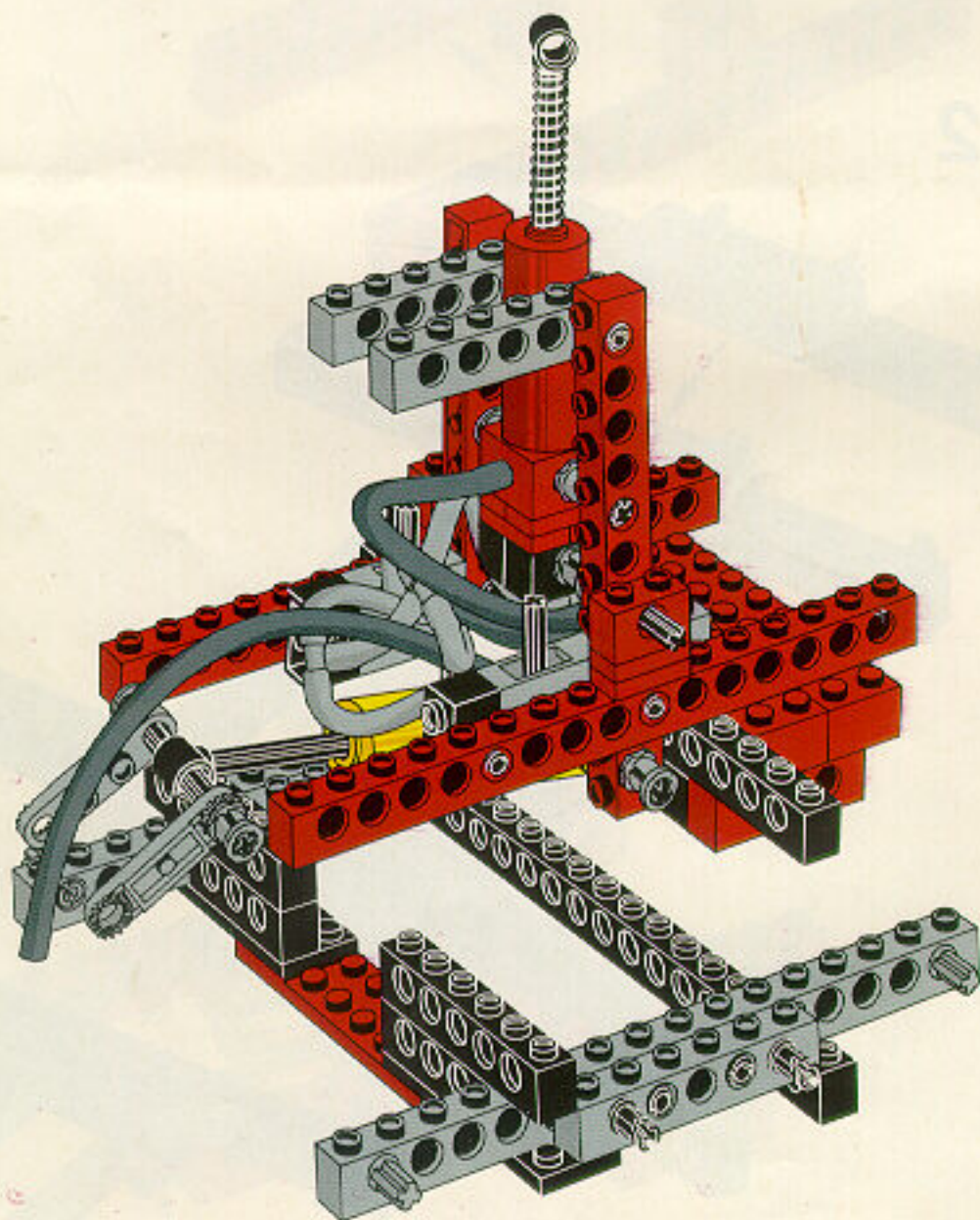



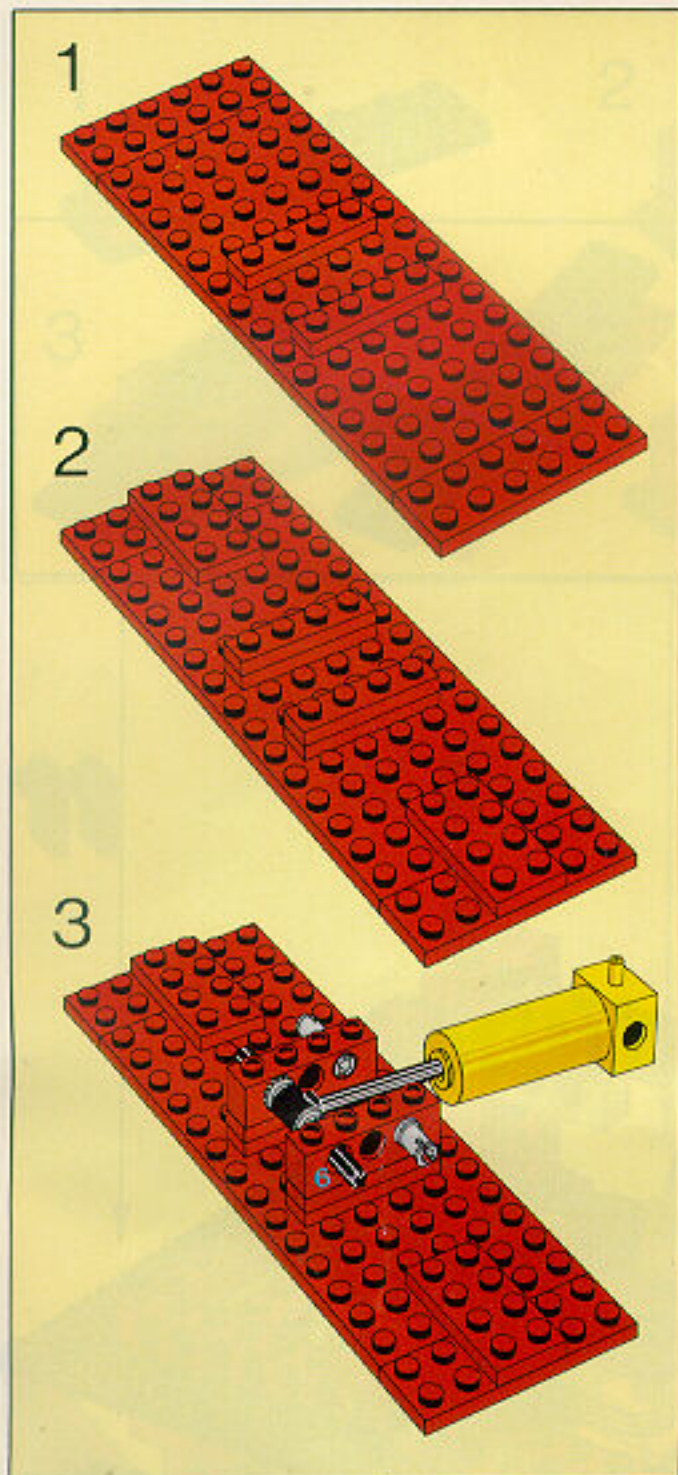

9

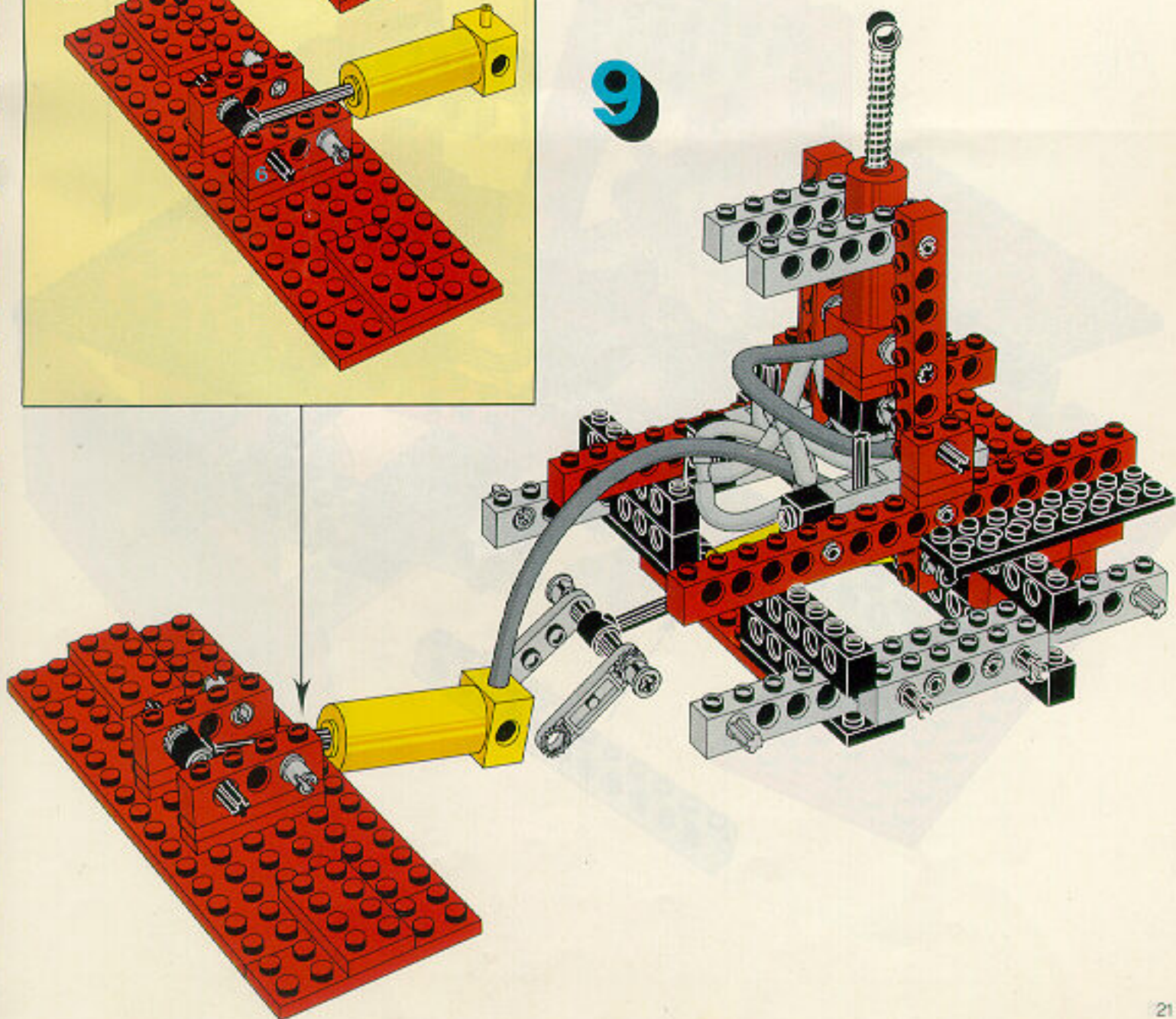



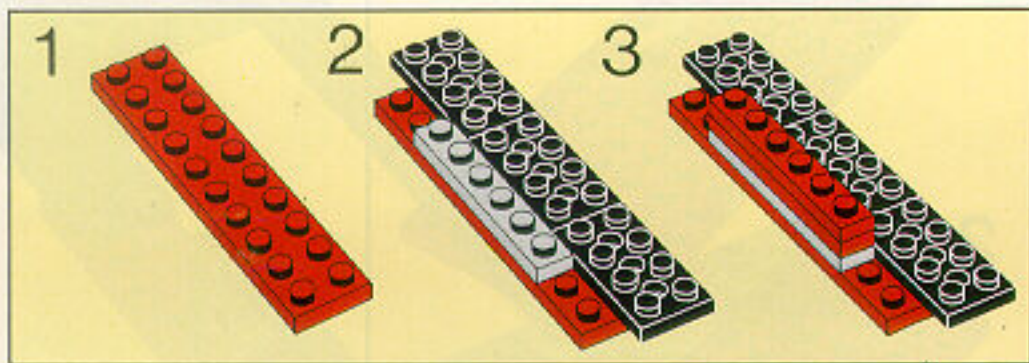

10

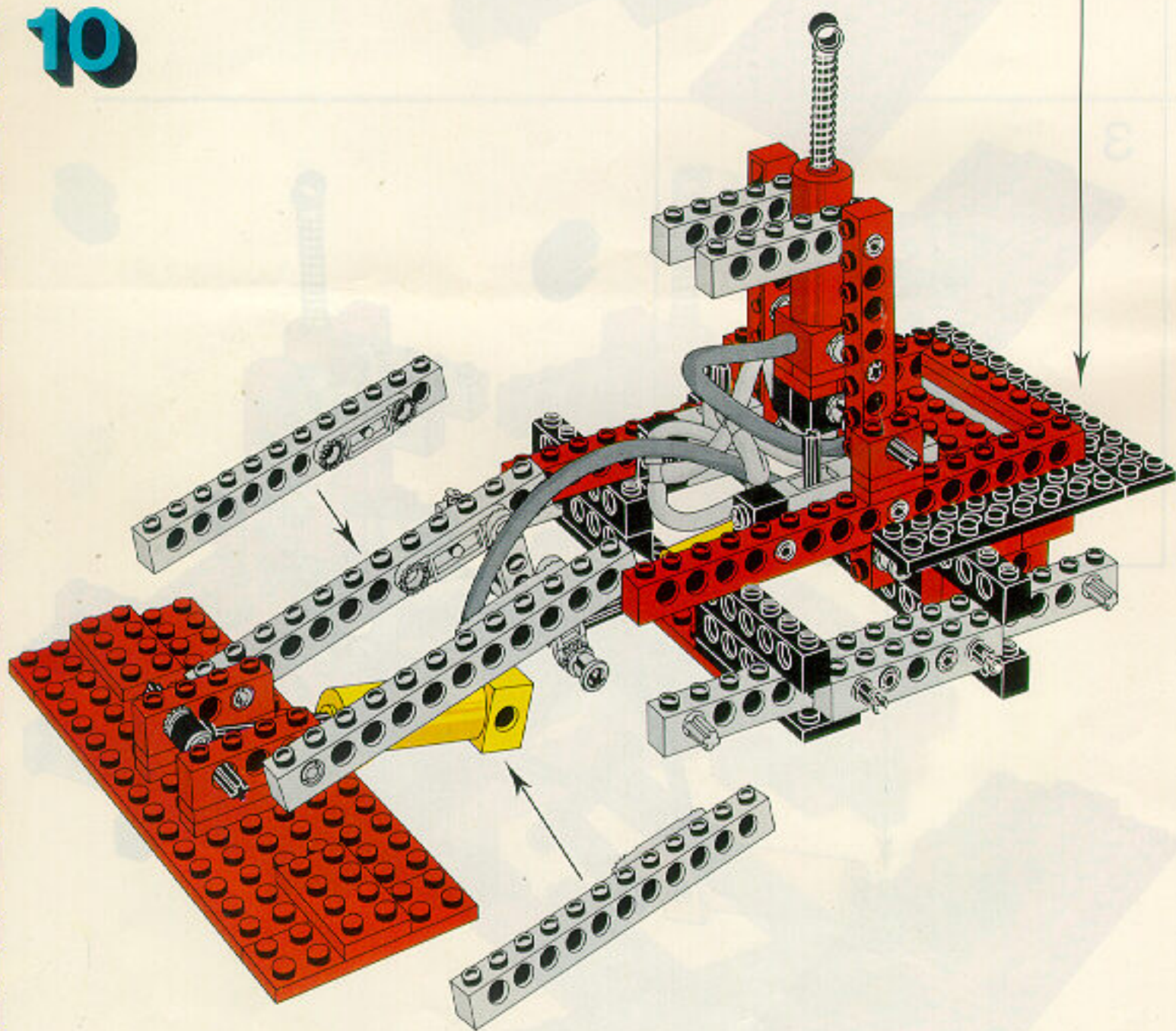







12

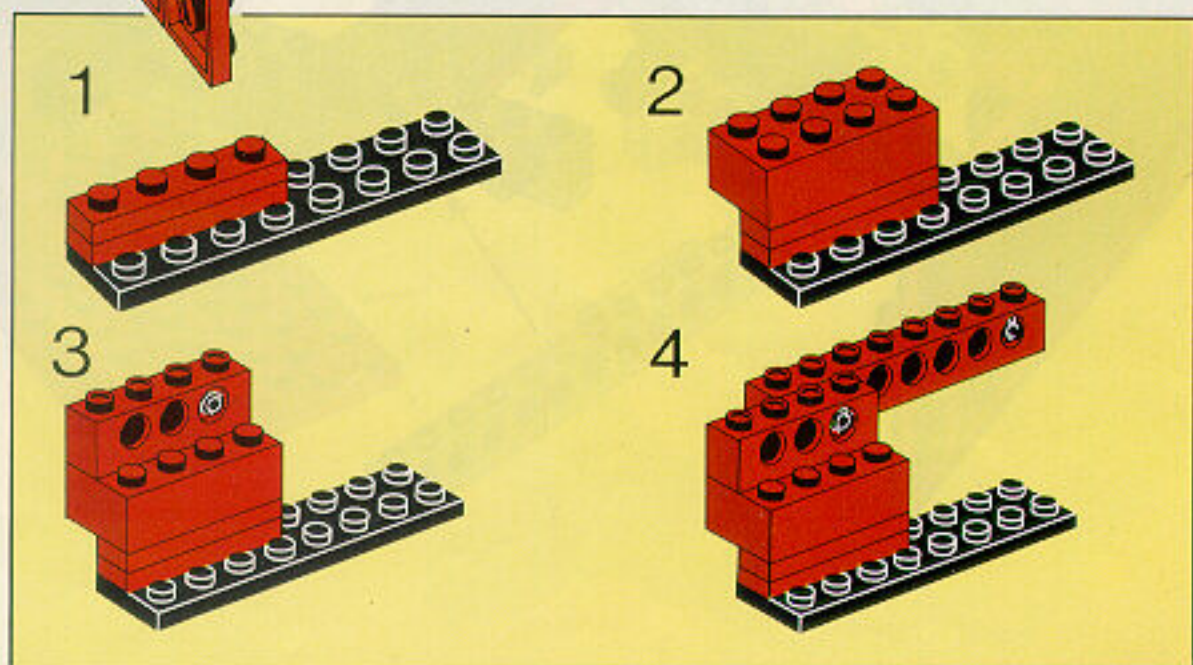
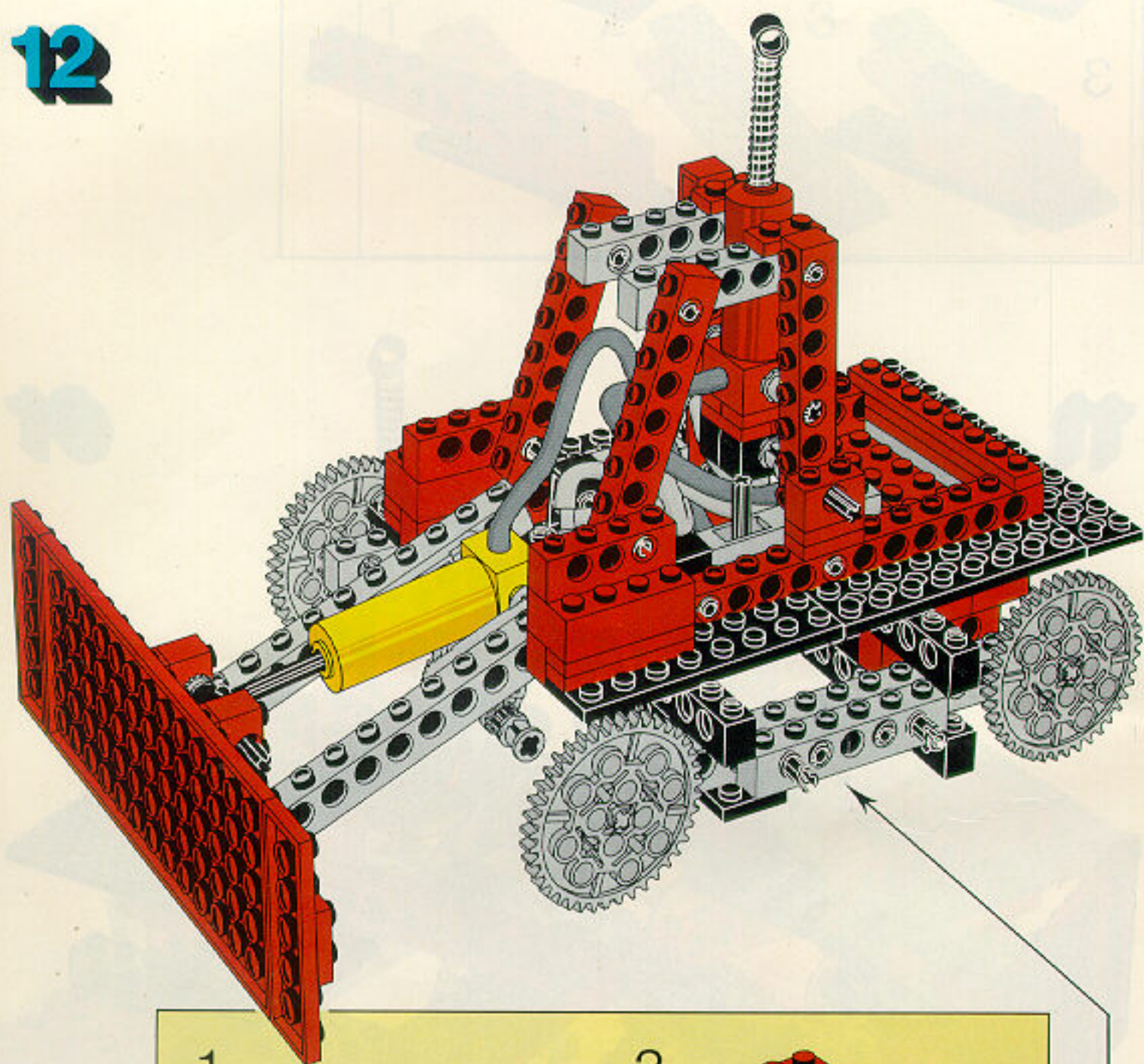



13

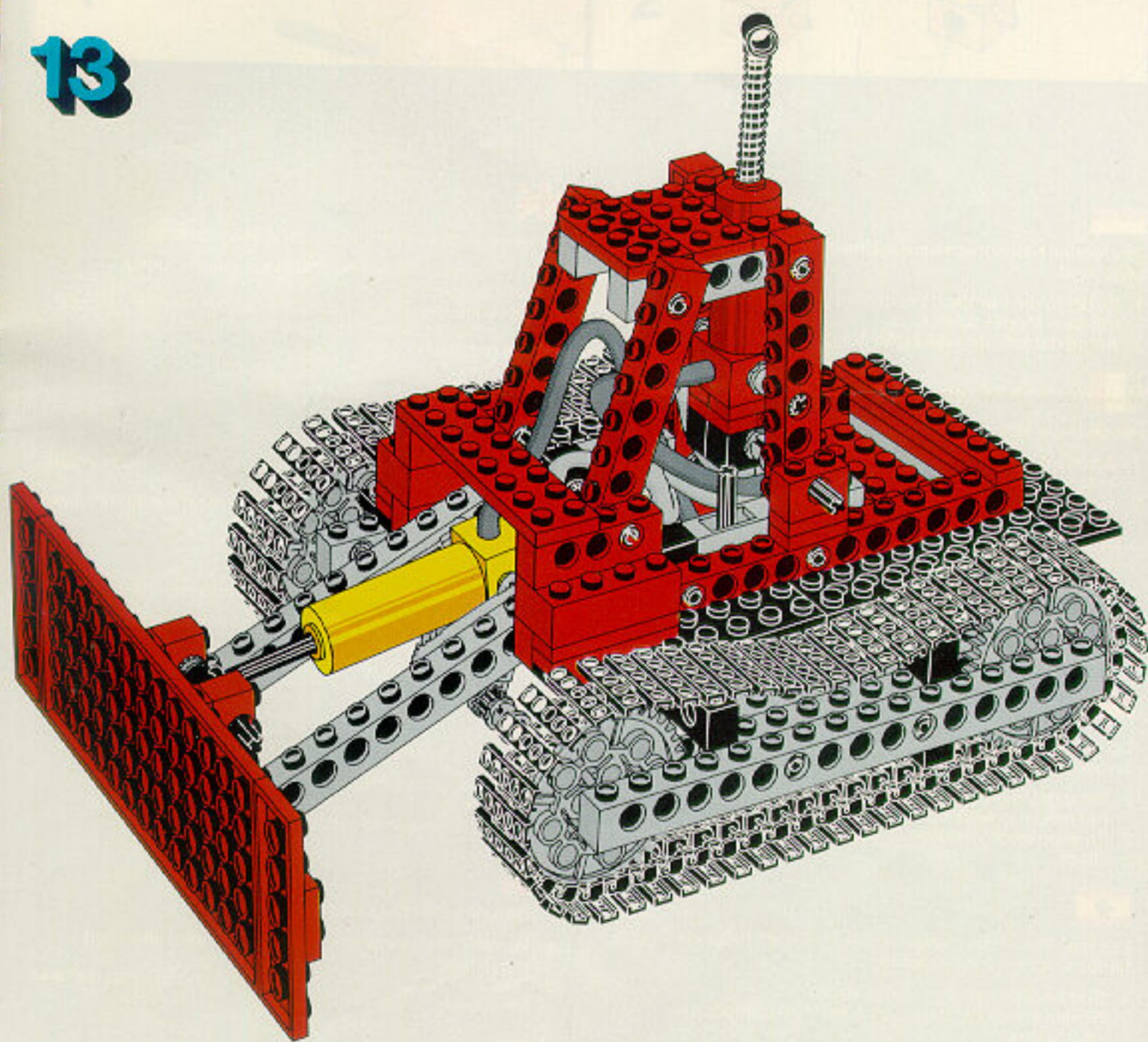



1

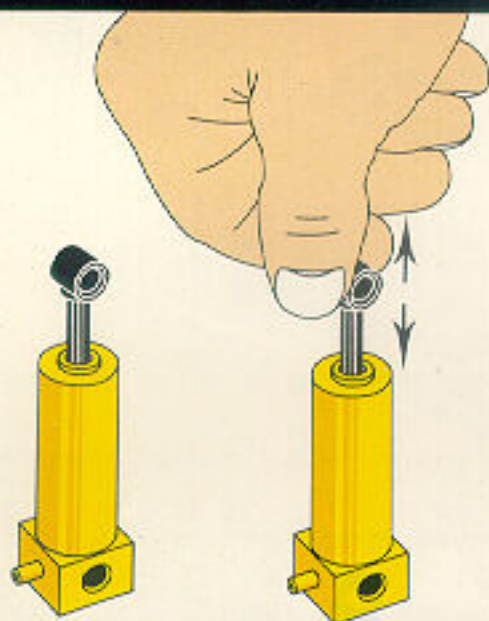

2



Das Modell funktioniert einwandfrei, wenn Du folgendes beachtest:

1. Betätige die Pumpe (Pneumatic) mit der Hand, bevor Du mit dem Modell spielst.
2. Achte darauf, dass die Luftleitungen keinen Knick haben.



Per un buon funzionamento è importante:

1. Azionare i cilindri manualmente prima di iniziare la costruzione.
2. Controllare che i tubicini non siano attorcigliati.



Pour un bon fonctionnement de vos modèles, n'oubliez pas :

1. De pomper l'air dans les cylindres à la main avant de jouer.
2. De vérifier que les flexibles ne sont pas coudés.



Tip: Modellen met Pneumatic werken het beste als je niet vergeet om:

1. Eerst de cylinders met de hand op te pompen, voordat je het model in werking zet.
2. En even te controleren of er geen kinken in de luchtslangen zitten.



Los modelos funcionarán mejor si antes de empezar a jugar tienes en cuenta lo siguiente:

1. Bombea los cilindros varias veces.
2. Revisa los tubos para que no estén ni doblados ni obstruidos.



Modellen virker bedst, hvis du altid husker følgende:

1. Pumpe cylindren med hånden, inden du leger med modellen.
2. Sørg for, at der ikke er knæk på slangene.



To ensure your Pneumatic model works correctly:

1. Test the pumping action at various points during construction.
2. Check the Pneumatic tubes are not constricted - i.e. use gentle curves rather than tight bends which may cause the tube to flatten.



Malli toimii parhaiten, jos sina muistat:

1. Pumpata sylintereihin ilmaa ennenkuin ryhdyt leikkimään mallilla.
2. Tarkistaa, etteivät letkut ole taittuneet tai vahingoittuneet.



Modellerna fungerar bäst om du alltid kommer ihåg:

1. Att göra några pumpningar på cylinderna innan du börjar leka med modellen.
2. Att se till att det inte är några veck på slangarna.



Os modelos funcionarão melhor se se lembrar sempre de:

1. Bombear os cilindros à mão, antes de brincar com o modelo.
2. Certificar-se que os tubos não têm dobras.



Modellene virker best hvis du:

1. Pumper opp sylindrene før du begynner å leke med modellene.
2. Forvisser deg om at slangen er riktig koblet og at den ikke har knekk.



Τα μοντέλα εργάζονται καλύτερα όταν θυμάστε πάντα:

1. Να τρομπάρτε με το χέρι, πριν παίξετε με το μοντέλο.
2. Να ελέγξετε αν τα σωληνάκια δεν είναι λυγισμένα.



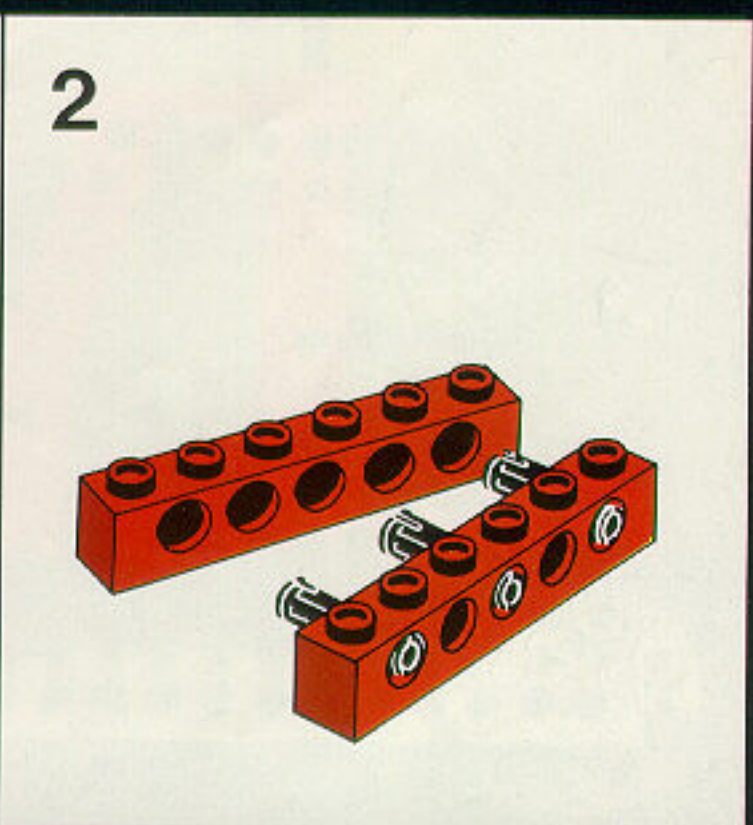
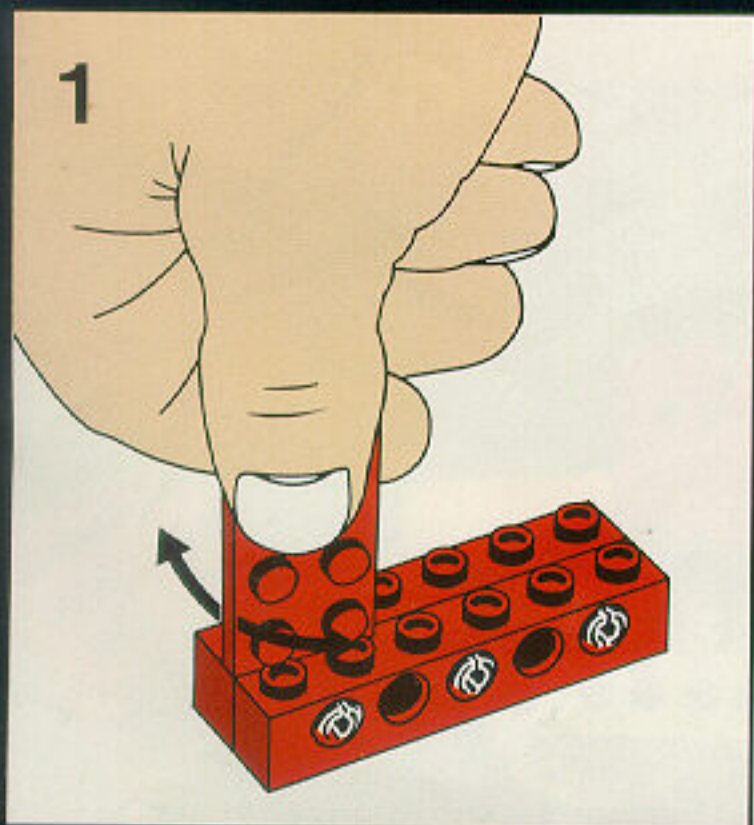
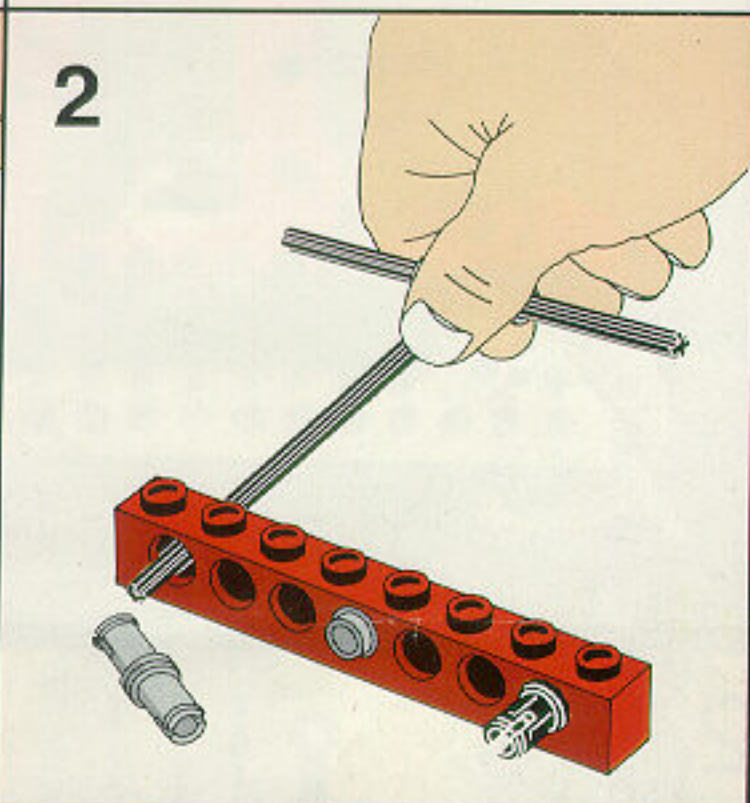
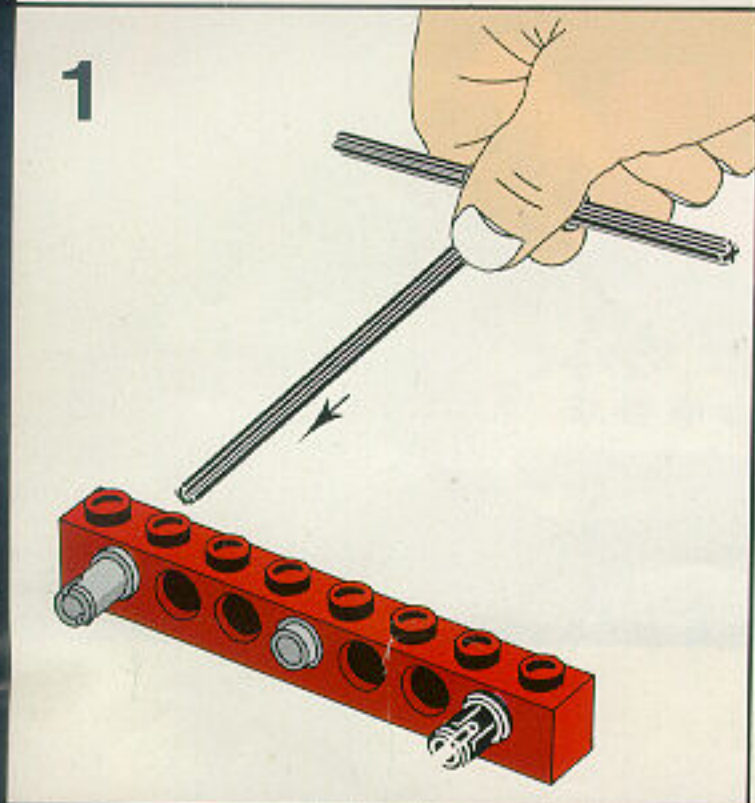
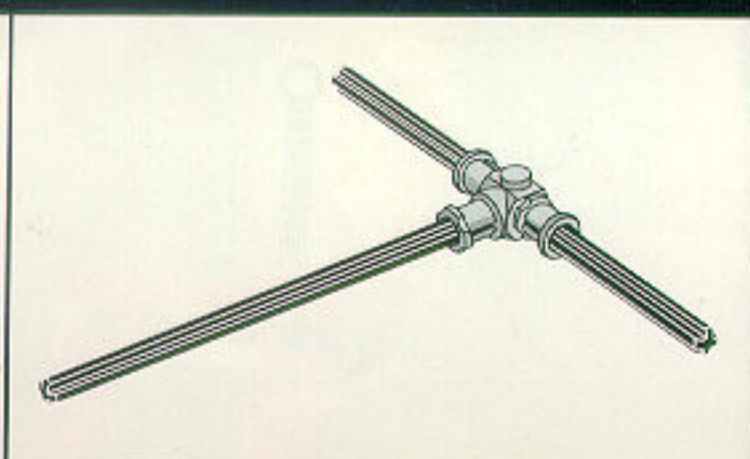
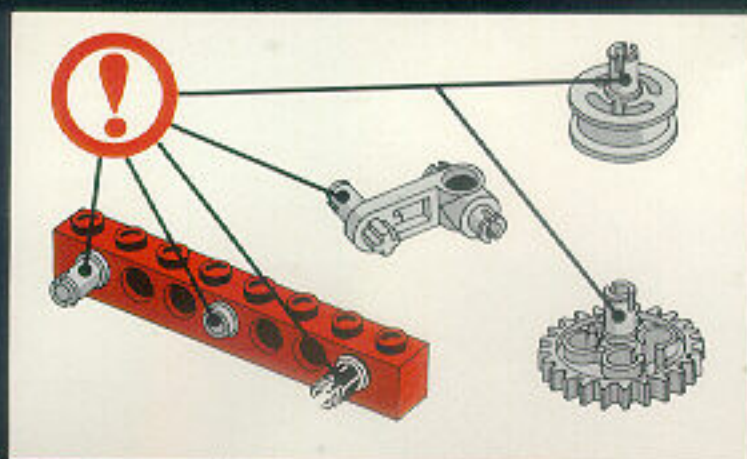



1

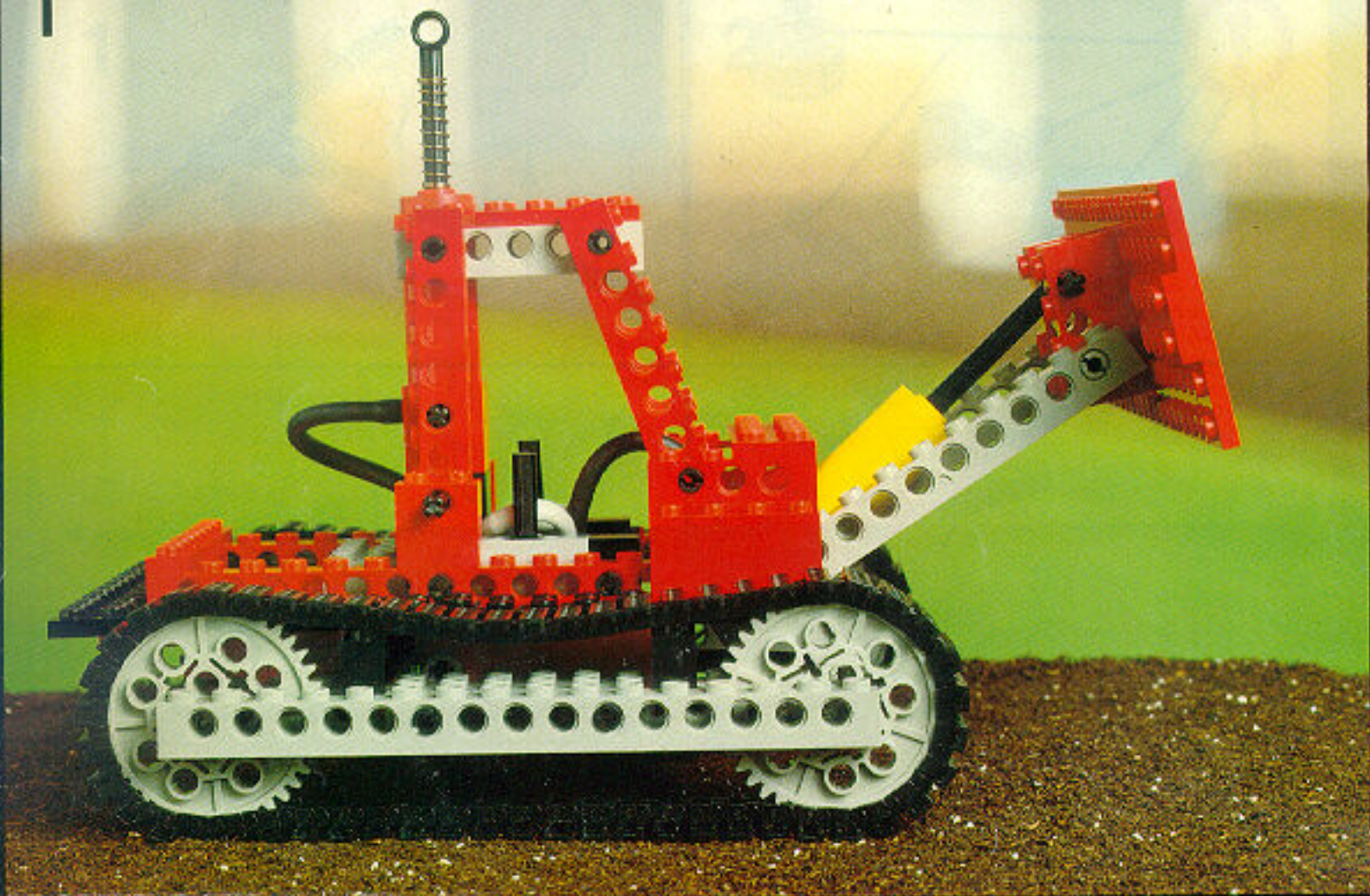

2

